

Electric Fan

|電|風|扇|



SINCE 1909
JAPAN



W56WV



170089-12



N30NH



071945-11

Breeze in
Harmony



SINCE 1909
JAPAN

Sole agent :
Capital Distributors (S) Pte Ltd
9 Tagore Lane #02-31 to 33
9@ Tagore, Singapore 787472
Tel: (65) 6288 9190
Fax: (65) 6288 5869
E-mail: sales@capital.com.sg
Website: www.kdk.sg

KDK Company, Division of PES
4017, Takaki-cho, Kasugai, Aichi, Japan
<http://kdk.jp>



* Specification are subject to change without prior notice.
* Actual colors may slightly vary from those shown.

- 規格如有變更，恕不另行通知。
- 實際的顏色可能會有些微差異。

CATALOG NO:K-SGEF004J1

01.19



Features of Electric Fan 電風扇特點

1/f yuragi Natural Breeze 自然韻律風

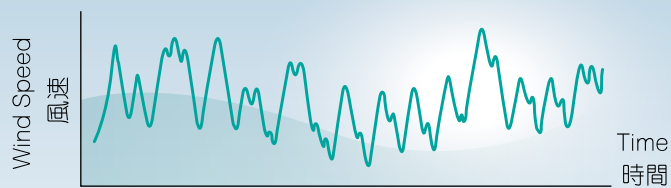

— Wind speed variation by 1/f Yuragi pattern
1/f Yuragi 韻律起伏之風速變化

1/f Yuragi is a fluctuation pattern that makes people feel comfortable. It exists in the gentle breeze on grassy plain, hypnotic rhythm of rolling waves and even in the classical music.

KDK incorporates this Yuragi pattern in its electric fan by varying air velocity to simulate the pattern of natural breeze, creating an extra comfort and refreshing environment for you to enjoy!

1/f Yuragi 是一種使人感到舒適的韻律起伏，存在於大自然的微風，海邊的波浪聲，甚至優雅的古典音樂。

KDK利用先進科技，把Yuragi的起伏應用於電風扇上，透過轉變風力強弱，而模仿自然風的韻律，讓您享受更舒適自然的清風！

Comment after 20 minutes usage 使用20分鐘後的意見

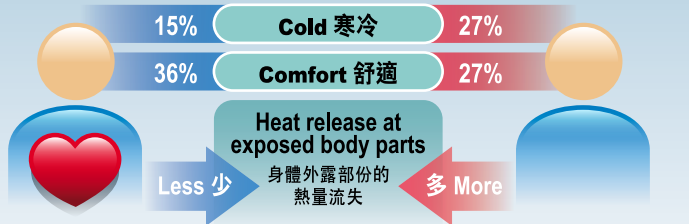

1/f Yuragi Wind Flow 1/f Yuragi 自然風

While enjoying the comfortable cooling effect, it prevents body temperature from dropping.

使人獲得舒適涼快感覺
而不會使體溫流失。

Japan Society of
Physiological Anthropology
Report
日本生理人類學會報告

Continuous Wind 不變的風

Body will get tired if exposed to wind for long time.

當長時間處於此環境，
人體較易感到疲倦。

Durable Ball Bearing type motor 耐用滾珠軸承式馬達

- High performance
- Long life (Endurance : 20,000 hrs)
- 高效能
- 耐用 (耐用度 : 20,000 小時)



Safe and Reliable 安全及可信

KDK electric fans comply safety standard in order to enhance and ensure the product safety. 為確保產品安全，KDK電風扇均符合安全標準。

SUPER alleru-buster

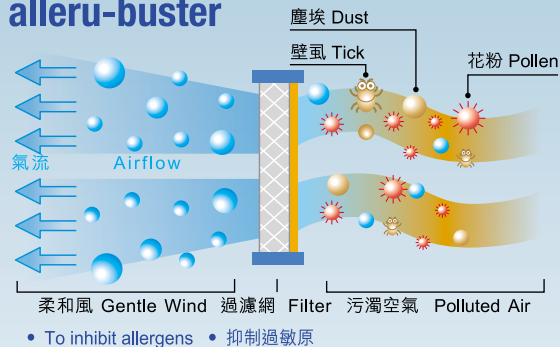

- To inhibit allergens • 抑制過敏原

Testing Unit: Osaka Municipal Technical Research Institute
Testing Method: Apply with enzyme immunoassay method proving the reduction on refined allergens

試驗機關：大阪市立工業研究所
試驗方法：採用酵素免疫測定法，證實過敏原的降低

Green Tea Catechin 「家庭健」兒茶素

- To inhibit virus 抑制病毒
- Catechin is a natural element extracted from green tea 「家庭健」兒茶素是從綠茶中提取的天然成份

The filter has unique fragrance of the Catechin that does no harm to human body
濾網具有「家庭健」兒茶素的特有香味，對人體無害。

Testing Unit: Kitasato Research Center of Environmental Sciences
Testing Method: To use Brack Method for proving the non-activity rate of virus
試驗機關：日本北里環境科學中心
試驗方法：採用布拉克法確實病毒的不活化

Anti-bacteria Enzyme 抗菌酵素

- To prevent reproduction of bacteria & molds 預防細菌及霉菌再生

Testing Unit: Japan Food Research Laboratories
Testing Method: Result confirmed by applying an outdoor planting method in a standard outdoor culture center

試驗機關：日本食品分析中心
試驗方法：在標準露天培養地，採用露天平板培養法進行確定

SPRING Singapore Safety Mark

Model M40KS



082304-11



Model T60AW



150117-12



Singapore KDK models that come with Capital Distributors warranty are registered with SPRING Singapore's Consumer Protection (Safety Requirements) Registration Scheme, which certifies that our products meet stringent safety standards and are safe for use in your home.

附有 Capital Distributors 保修證書的 KDK 新加坡型號，是獲得新加坡標準、生產力與創新局 "消費者保 (安全標準) 註冊計劃" 認證的 KDK 型號。這意味著我們的產品通過了嚴格的安全標準檢測，是非常安全的家用產品。

LIVING FAN 優美扇



N30NH
30cm (12")



071945-11

1/2 yuragi

- 1/f Yuragi function
- Slim and Compact motor design
- 3-speed and electronic ON/OFF switch
- Wireless remote control
- 4-hour electronic timer
- Height adjustable: 91cm-105cm (36"-41")
- Transparent plastic blade
- Color: ● Metallic Bronze or ● Premium Gold

- 1/f 自然韻律風功能
- 獨有超平背式設計
- 三段風速調節及電子開關
- 附無線遙控器
- 四小時電子時間掣
- 可調節高度：91厘米-105厘米(36吋-41吋)
- 透明塑膠扇葉
- 顏色：●金屬青銅色或●金灰色



Remote Control
無線遙控器

● Premium Gold

Compact Motor Design

創新超平背設計

Compact Motor Design for saving space
令機身更細更輕位



P30KH
30cm (12")



062015-11

1/2 yuragi



- 1/f Yuragi function
- Attached air filter combines Super alleru-buster, Green Tea Catechin and Anti-bacteria Enzyme function
- 3-speed and electronic ON/OFF switch
- Wireless remote Control
- Height adjustable: 66 cm-85 cm (26" - 33")
- 4-hour electronic timer
- Transparent plastic Blade
- Color : ● Champagne Gold

- 1/f 自然韻律風功能
- 附抑制過敏原體，「家庭健」兒茶素，抗菌酵素功能於一身的過濾網
- 三段風速調節及電子開關
- 無線遙控
- 可調校高度：66厘米-85厘米(26吋-33吋)
- 4小時電子時間掣
- 透明塑膠扇葉
- 顏色：●香檳金色



Remote Control
無線遙控器

● Champagne Gold

1/2 yuragi



Remote Control
無線遙控器

● Champagne

M40KS
40cm (16")



082304-11

1/2 yuragi



- 1/f Yuragi function
- Attached air filter combines Super alleru-buster, Green Tea Catechin and Anti-bacteria Enzyme function
- 3-speed and electronic ON/OFF switch
- 6-hour electronic timer
- Height adjustable: 128cm-143cm (50"-56")
- Wireless remote control
- Transparent plastic blade
- Color: ● Champagne or ● Titan Gray

- 1/f 自然韻律風功能
- 附抑制過敏原體，「家庭健」兒茶素，抗菌酵素功能於一身的過濾網
- 三段風速調節及電子開關
- 六小時電子時間掣
- 可調節高度：128厘米-143厘米(50吋-56吋)
- 附無線遙控器
- 透明塑膠扇葉
- 顏色：●香檳色或●鈦灰色



N40HS
40cm (16")



071946-11

- 1/f Yuragi function
- Attached air filter combines Super alleru-buster, Green Tea Catechin and Anti-bacteria Enzyme function
- 3-speed and electronic ON/OFF switch
- 6-hour electronic timer
- Height adjustable: 128cm-143cm (50"-56")
- Transparent plastic blade
- Color: ● Champagne or ● Titan Gray

- 1/f 自然韻律風功能
- 附抑制過敏原體，「家庭健」兒茶素，抗菌酵素功能於一身的過濾網
- 三段風速調節及電子開關
- 六小時電子時間掣
- 可調節高度：128厘米-143厘米(50吋-56吋)
- 透明塑膠扇葉
- 顏色：●香檳色或●鈦灰色

● Titan Gray

PL30H
30cm (12")



111257-12

- 3-speed and electronic ON/OFF switch
- Rhythm breeze function
- 4-hour electronic timer
- Height adjustable: 69 cm-88 cm (28" - 35")
- Light Grey/Blue Transparent Blade
- Color : ● White, ● Black or ● Blue

- 三段風速調節及電子開關
- "韻律送風"功能，風速有節奏地自然吹送
- 四小時電子時間掣
- 可調校高度：69厘米-88厘米(28吋-35吋)
- 淺灰/藍色透明扇葉
- 顏色：●白色、●黑色或●藍色



● White

● Black

● Blue

PEDESTAL FAN 座地扇

P40US

40cm (16")



062162-11

- 3-speed and ON/OFF push-button switch
- Height adjustable: 129 cm-154 cm (50³/₄"-60¹/₂")
- Metal blade
- Color: ● Gold, ● Champagne or ○ White

- 三段風速調節及按鈕開關
- 可調節高度：129厘米-154厘米 (50³/₄吋-60¹/₂吋)
- 金屬扇葉
- 顏色：● 金色、● 香檳色或○ 白色



● Gold

● Champagne



P40VS

40cm (16")



062161-11

- 3-speed and ON/OFF push-button switch
- 6-hour mechanical timer
- Height adjustable: 134cm-157cm (52³/₄"-61³/₄")
- Metal blade
- Color: ● Gold

- 三段風速調節及按鈕開關
- 六小時時間掣
- 可調節高度：134厘米-157厘米(52³/₄吋 - 61³/₄吋)
- 金屬扇葉
- 顏色：● 金色

● Gold

BOX FAN 行運扇

ST30H

30cm (12")



131734-12

1/2 yuragi

- 1/f Yuragi function
- 3-speed and electronic ON/OFF switch
- Revolving front louver
- 8-hour electronic timer
- Opaque plastic blade
- Color: ● lavender, ● gray

- 1/f 自然韻律風功能
- 三段風速調節及電子開關
- 旋轉式前置式百葉窗
- 八小時電子時間掣
- 不透明塑膠扇葉
- 顏色：● 紫色或 ● 灰色



● Lavender

SS30H

30cm (12")



131735-12

1/2 yuragi

- 1/f Yuragi function
- 3-speed and electronic ON/OFF switch
- Revolving front louver
- 8-hour electronic timer
- Height adjustable: 80cm-97cm (31"-38")
- Adjustable tilt angle: 90°/45°
- Opaque plastic blade
- Color: ● lavender, ● gray

- 1/f 自然韻律風功能
- 三段風速調節及電子開關
- 旋轉式前置式百葉窗
- 八小時電子時間掣
- 80厘米-97厘米 (31吋-38吋)
- 可調節傾斜度：90°/45°
- 不透明塑膠扇葉
- 顏色：● 紫色或 ● 灰色



● Gray

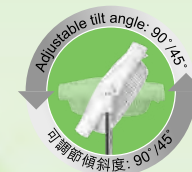

Adjustable tilt angle: 90°/45°
可調節傾斜度：90°/45°

SD30H

30cm (12")



131736-12

1/2 yuragi

- 1/f Yuragi function
- 3-speed and electronic ON/OFF switch
- Ultra-thin wireless remote controller
- Revolving front louver
- 8-hour electronic timer
- Opaque plastic blade
- Color: ● lavender, ● gray

- 1/f 自然韻律風功能
- 三段風速調節及電子開關
- 輕巧無線遙控器
- 旋轉式前置式百葉窗
- 八小時電子時間掣
- 不透明塑膠扇葉
- 顏色：● 紫色或 ● 灰色



● Gray

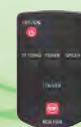

Remote Control
無線遙控器

SC30H

30cm (12")



131737-12

1/2 yuragi

- 1/f Yuragi function
- 3-speed and electronic ON/OFF switch
- Ultra-thin wireless remote controller
- Revolving front louver
- 8-hour electronic timer
- Height adjustable: 80cm-97cm (31"-38")
- Adjustable tilt angle: 90°/45°
- Opaque plastic blade
- Color: ● lavender, ● gray

- 1/f 自然韻律風功能
- 三段風速調節及電子開關
- 輕巧無線遙控器
- 旋轉式前置式百葉窗
- 八小時電子時間掣
- 80厘米-97厘米 (31吋-38吋)
- 可調節傾斜度：90°/45°
- 不透明塑膠扇葉
- 顏色：● 紫色或 ● 灰色



● Lavender



Adjustable tilt angle: 90°/45°
可調節傾斜度：90°/45°

Remote Control
無線遙控器

DESK FAN 座檯扇



● Silver Blue



● Silver Gray

A30AS
30cm (12")

SAFETY MARK
991771-00

A40AS
40cm (16")

SAFETY MARK
991775-00

- 3-speed and ON/OFF push-button switch
- Transparent plastic blade
- Detachable base for easy storage
- Color: ● Silver blue or ● Silver Gray
- 三段風速調節及按鈕開關
- 透明塑膠扇葉
- 可裝卸式底座，易於收藏
- 顏色：●銀藍色或●銀灰色

ORBITAL FAN 樓底扇



● Gray



● Blue

M40RS
40cm (16")

SAFETY MARK
082301-11

- 5-speed and ON/OFF regulator
- 360° oscillation
- Easy angle adjustment
- Metal blade
- Color: ● Gray or ● Blue
- 5段風速調節及旋鈕開關
- 360°度擺動
- 簡易調校送風角度
- 金屬扇葉
- 顏色：●灰色或●藍色

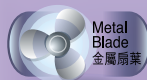

WALL FAN 掛牆扇



● Black



● Gray

Remote Control
無線遙控器

M40MS
40cm (16")

SAFETY MARK
082305-11

Super alleru-buster Filter

- Attached air filter combines Super alleru-buster, Green Tea Catechin and Anti-bacteria Enzyme function
- 3-speed and electronic ON/OFF switch
- 6-hour electronic timer
- Full-operation remote control for speed and oscillation
- Transparent plastic blade
- Color: ● Gray or ● Black
- 附抑制過敏原體，「家庭健」兒茶素，抗菌酵素功能於一身的過濾網
- 三段風速調節及電子開關
- 六小時電子時間掣
- 全功能速度(風量)控制及擺動控制遙控器
- 透明塑膠扇葉
- 顏色：●灰色或●黑色



● Gray

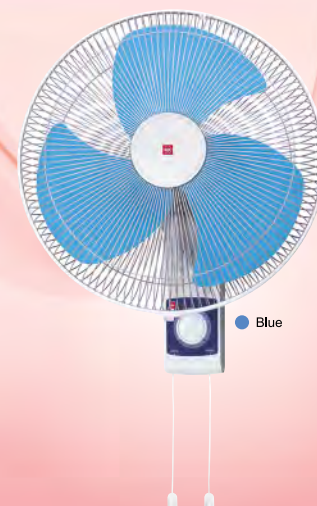

● Blue

M30CS
30cm (12")

SAFETY MARK
082302-11

M40CS
40cm (16")

SAFETY MARK
082303-11

- 3-speed and ON/OFF pull switch
- Pull switch Oscillation control
- Blade: M30CS - Opaque plastic blade
M40CS - Metal blade
- Color: ● Blue or ● Gray



- 三段風速調節及拉掣開關
- 拉掣控制擺動
- 扇葉：M30CS - 不透明塑膠扇葉
M40CS - 金屬扇葉
- 顏色：●藍色或●灰色

Features of Ceiling Fan 吊扇特點

Cut-off Safety Switch 安全斷電掣

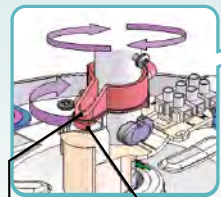
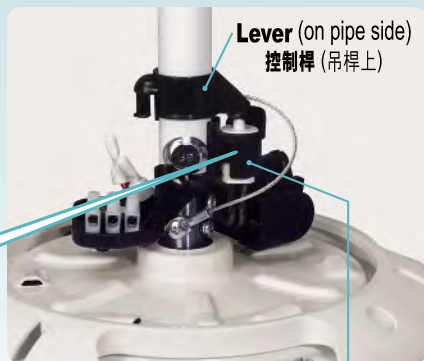
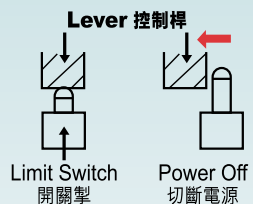

The lever moves to the direction of rotation
控制桿順旋轉方向移動

Limit Switch is activated
起動開關掣

Safety Switch
Cut-off power before fracture
安全斷電掣
部件斷開前切斷電源

As abnormal wobbling occurs, the lever detaches from the switch and the fan will stop. It prevents further wear of damaged parts to minimize the possibility of falling of fan.
當有異常擺動時，控制桿會移離開關掣，使風扇停止。這可以防止磨損部位加劇磨損，降低風扇墜下的可能性。

Blade Safety Hanger 扇葉防墜掛鈎

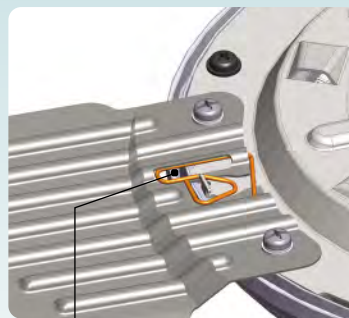

e.g. Regulator Control Type
電容控制調節器型號



The hanger hooks the blade as it detaches from the screws

Safety Hanger
(Fall Prevention Hanger)
防墜掛鈎 (扣在扇葉上)

An exclusively designed fall prevention hanger equipped. This mechanism secures against falling of blades caused by damaging wear.
馬達備有獨特設計的防墜掛鈎防止扇葉片掉下。

Direct Current Motor 直流馬達

DC Motor Type only
直流馬達系統通用

Newly developed direct current (DC) motor are adopted in these fans. Power consumption is reduced as compared with alternative current (AC) motor that energy saving is achieved.

DC motor has lighter weight compared with conventional AC motor, that allows easy handling for DC ceiling fan.

使用全新開發直流馬達，相比交流馬達更能減少電力損耗，達至節省能源。另外，直流馬達重量較輕，在安裝直流馬達吊扇時更方便。

Direct Current (DC) Motor 直流馬達

Electric power input is required for stator only
只有定子需要電力

Rotor: Permanent Magnet
轉子：永久磁石

Electric Power Input
電力輸入

Stator: Electromagnet
定子：電磁石

Alternative Current (AC) Motor 交流馬達

Electric power input is required for both rotor and stator
轉子和定子都需要電力

Rotor: Electromagnet
轉子：電磁石

Electric Power Input
電力輸入

Stator: Electromagnet
定子：電磁石

| | Motor Type 馬達類型 | Power Consumption at Hi Speed I/W 在高時電力消耗 (瓦) |
|-------------------------|--------------------|--|
| T60AW | DC / 直流 | 39 |
| Other Brand 其他牌子 | AC / 交流 | 94 |
| | | 59% reduced 減少59% |

As of 230V 50Hz / 於230V 50Hz 的數據

LED Lighting LED照明

U48FP/U60FW only
U48FP/U60FW 型號通用

The LED light has different brightness or colors selection. Incorporated with the contemporary interior, they can foster a charming atmosphere to the room.
我們的吊扇提供不同的光度及顏色，配合現代室內設計，營造出高尚格調。



U60FW
White Lamp
白燈



U60FW/U48FP
Cool Daylight Lamp
冷日光燈

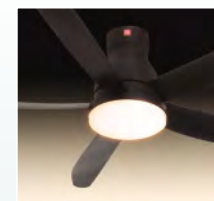

U60FW
Warm Lamp (Medium/Low)
暖光燈 (中/低)

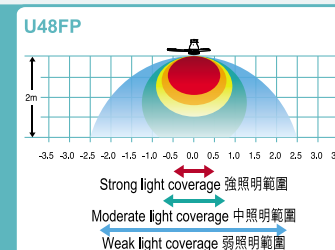
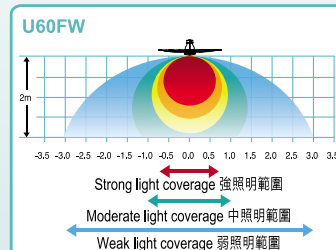

Actual brightness may vary slightly from time to time 實際光度會隨長時間使用而改變

LED Specifications LED燈規格

| | U60FW | U48FP |
|---|---|---|
| Power Consumption (Light Only) 電力消耗 (只有燈光) | 22W | 18W |
| LED Brightness LED光度 | Max: 200 lx (White Color) Middle: 150 lx (Cool Daylight, Warm Color) Low: 3 lx (Low Warm Color) | Max: 150 lx (Cool Daylight Color) Middle: 75 lx (Cool Daylight Color) Low: 3 lx (Cool Daylight Color) |

Auto Mode - Thermal Sensor 自動模式 - 溫度感應

This function controls the fans to generate the most comfortable air velocity to human body subject to the change of room temperature.

該功能因應室溫的變化而調節風扇，從而產生人體感受最舒適的風速。



1 Thermal Sensor detects room temperature 溫度感應器檢測室溫

1M From Floor
地面以上1米

Sensible Temperature 體感溫度

Sensible temperature stands for the temperature felt by human being. It is not the same as the thermometer recorded. We lost heat when we expose to cool air. The greater the wind speed, the faster we lose heat.

體感溫度表示人體感受的溫度，與溫度計檢測的讀數不同。當我們暴露於冷空氣，會失去的熱量，風速越大，失熱速度越快。

2 Motor speed is adjusted 調節馬達轉速

Change of wind velocity according to measured data
根據測量數據而調節風速

3 Actual data is monitored 監控實測數據

Temperature difference around the ceiling fan is corrected by actual measured data.
根據測量數據修正吊扇周邊的溫度差

The sensor monitors the temperature change in the room and air velocity will vary automatically in accordance to below table.

溫度感應器檢測室溫變化並根據以下列表自動調節風速。

| Range of Room Temperature 室溫範圍 | Change of Room Temperature 室溫變化 | | Change of Speed V60WK 轉速變化 | |
|--------------------------------|---------------------------------|------|----------------------------|-----|
| | -1°C | +1°C | - | + |
| Above 29°C ↑ 高過 29°C ↑ | Blue | Red | Blue | Red |
| 29°C - 23°C | Blue | Red | Blue | Red |
| Below 23°C ↓ 低過 23°C ↓ | Blue | Red | No Change 不變 | |

Example of V56VK
以V56VK為例

3D Blade 3D扇葉

T60AW/T60DW only
T60AW/T60DW 型號適用

The exclusive and unique 3D blade design provides smooth and strong air flow while maintaining operating noise in low level.

獨有的3D扇葉設計提供強力流暢送風，同時保持低噪音操作。

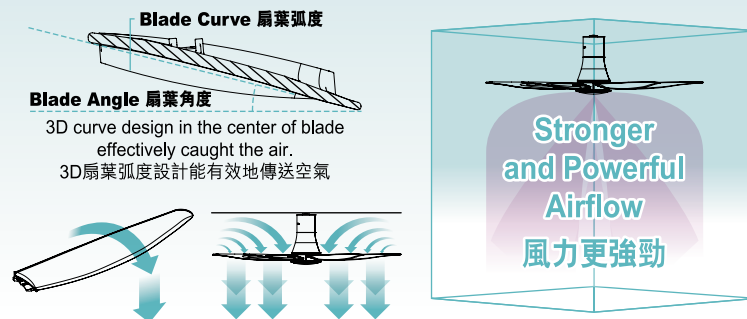

Sleep Mode 睡眠模式

The fan is equipped with Sleep Mode, by which fan speed and timer will gradually go down until the fan is off. The function not only creates an optimal sleeping environment, but also enhances energy saving as well.

備有睡眠模式，風速隨計時器倒數而減慢直至關掉。為你提供優質的睡眠環境，更能節省能源。

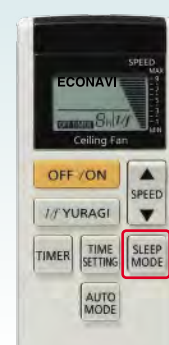

Remote Control for T60AW
T60AW 遙控器

Sleep Mode 睡眠模式 Example for Speed 9 & Speed 6 of T60AW/T60DW
(以T60AW/T60DW 型號的第九和第六段風速為例)

| | 8H | 7H | 6H | 5H | 4H | 3H | 2H | 1H | 0 |
|--------------------|----|----|----|----|----|----|----|----|-----|
| Speed 9 第九段 | ON | ON | ON | ON | ON | ON | ON | ON | OFF |
| | ON | ON | ON | ON | ON | ON | ON | ON | OFF |
| | ON | ON | ON | ON | ON | ON | ON | ON | OFF |
| | ON | ON | ON | ON | ON | ON | ON | ON | OFF |
| | ON | ON | ON | ON | ON | ON | ON | ON | OFF |
| | ON | ON | ON | ON | ON | ON | ON | ON | OFF |
| | ON | ON | ON | ON | ON | ON | ON | ON | OFF |
| | ON | ON | ON | ON | ON | ON | ON | ON | OFF |
| | ON | ON | ON | ON | ON | ON | ON | ON | OFF |
| | ON | ON | ON | ON | ON | ON | ON | ON | OFF |
| Speed 6 第六段 | ON | ON | ON | ON | ON | ON | ON | ON | OFF |
| | ON | ON | ON | ON | ON | ON | ON | ON | OFF |
| | ON | ON | ON | ON | ON | ON | ON | ON | OFF |
| | ON | ON | ON | ON | ON | ON | ON | ON | OFF |
| | ON | ON | ON | ON | ON | ON | ON | ON | OFF |
| | ON | ON | ON | ON | ON | ON | ON | ON | OFF |
| | ON | ON | ON | ON | ON | ON | ON | ON | OFF |
| | ON | ON | ON | ON | ON | ON | ON | ON | OFF |
| | ON | ON | ON | ON | ON | ON | ON | ON | OFF |

On Timer 開機時間掣

T60AW/T60DW only
T60AW/T60DW 型號適用

On Timer can be incorporated with air conditioner to realize economy and comfortable operation. It can minimize excessive cold feeling and save power consumption during your sleep.

開機時間掣能配合空氣調節以達到經濟效益及舒適效果。在你睡眠時，減少寒冷感覺並能節省能源。

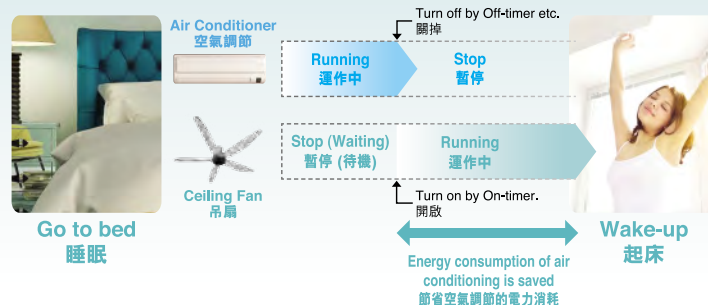

CEILING FAN 吊扇

DC MOTOR DC MOTOR TYPE 直流馬達系列



● Black



○ White



LCD Remote Control
LCD 無線遙控器

U60FW

150cm (60")



151416-12

1/2 Yuragi

- Dual function : Fan and Light
- Direct Current (DC) motor adopted
- Selectable light color (White/Daylight/Warm)
- 1/2 Yuragi Function
- 3D blade delivers smooth and strong airflow
- PPG Blade material for durability
- LCD wireless remote control
- 9-speed control
- Sleep mode with On timer & Off timer
- Equipped with safety device
- Blade safety plate and safety wire attached
- Color: ●Black or ○White
- Pipe length: Long or Short

- 風扇和照明二合一
- 採用直流馬達
- 可選擇不同燈光顏色
- 1/2 自然韻律風功能
- 3D扇葉設計提供強力流暢送風
- 扇葉採用PPG耐用物料
- LCD無線遙遠控制
- 九段風速調節
- 睡眠模式連開機及關機時間掣
- 安全斷電裝置
- 備有扇面防壁裝置及安全鋼線
- 顏色: ●黑色或○白色
- 吊桿長度: 長或短



● Black



○ White



LCD Remote Control
LCD 無線遙控器

U48FP

120cm (48")



151415-12

1/2 Yuragi

- Dual function : Fan and Light
- Direct Current (DC) motor adopted
- 1/2 Yuragi Function
- 3D blade delivers smooth and strong airflow
- PPG Blade material for durability
- LCD wireless remote control
- 9-speed control
- Sleep mode with On timer & Off timer
- Equipped with safety device
- Blade safety plate and safety wire attached
- Color: ●Black or ○White

- 風扇和照明功能二合一
- 採用直流馬達
- 1/2 自然韻律風功能
- 3D扇葉設計提供強力流暢送風
- 扇葉採用PPG耐用物料
- LCD無線遙遠控制
- 九段風速調節
- 睡眠模式連開機及關機時間掣
- 安全斷電裝置
- 備有扇面防壁裝置及安全鋼線
- 顏色: ●黑色或○白色

W56WV

140cm (56")



170089-12

1/2 Yuragi



● Black

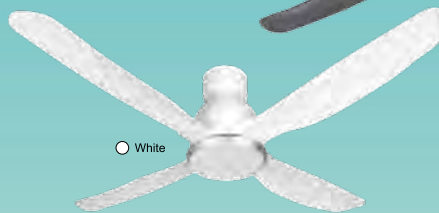

○ White



LCD Remote Control
LCD 無線遙控器

- Direct current (DC) motor adopted
- 1/2 Yuragi function
- 3D blade delivers smooth and strong airflow
- PPG blade material for durability
- LCD wireless remote control
- 9-speed control
- Sleep mode with On timer & Off timer
- Equipped with safety device
- Blade safety plate and safety wire attached
- Colour: ●Black or ○White

- 採用直流馬達
- 1/2 自然韻律風
- 3D 扇葉設計提供強力流暢送風
- 扇葉採用 PPG 耐用物料
- LCD 無線遙遠控制
- 九段風速調節
- 睡眠模式連開機及關機時間
- 安全斷電裝置
- 備有扇面防壁裝置及安全鋼線
- 顏色: ●黑色或○白色



LCD Remote Control
LCD 無線遙控器



T60AW

150cm (60")



150117-12

1/2 Yuragi

- Direct current (DC) motor adopted
- Auto mode with Eco Mode function by temperature sensor
- 1/2 Yuragi function
- 3D blade delivers smooth and strong airflow
- PPG blade material for durability
- LCD wireless remote control
- 9-speed control
- Sleep mode with On timer & Off timer
- Equipped with safety device
- Blade safety plate and safety wire attached

- 採用直流馬達
- 備有溫度感應的自動模式及節能模式
- 1/2 自然韻律風功能
- 3D扇葉設計提供強力流暢送風
- 扇葉採用PPG耐用物料
- LCD無線遙遠控制
- 九段風速調節
- 睡眠模式連開機及關機時間掣
- 安全斷電裝置
- 備有扇面防壁裝置及安全鋼線



LCD Remote Control
LCD 無線遙控器



T60DW

150cm (60")



150118-12

1/2 Yuragi

- Direct current (DC) motor adopted
- 1/2 Yuragi function
- 3D blade delivers smooth and strong airflow
- PPG blade material for durability
- LCD wireless remote control
- 9-speed control
- Sleep mode with On timer & Off timer
- Equipped with safety device
- Blade safety plate and safety wire attached

- 採用直流馬達
- 1/2 自然韻律風功能
- 3D扇葉設計提供強力流暢送風
- 扇葉採用PPG耐用物料
- LCD無線遙遠控制
- 九段風速調節
- 睡眠模式連開機及關機時間掣
- 安全斷電裝置
- 備有扇面防壁裝置及安全鋼線

CEILING FAN 吊扇

WIRELESS REMOTE CONTROL TYPE 無線遙控系列



V56VK

140cm (56")

1/2 yuragi

SAFETY
082166-11

- Temperature Sensor
- LED illumination lamp equipped
- 1/2 Yuragi function
- 5 speed
- LCD wireless remote controller
- 3D blade delivers smooth and strong airflow
- PPG blade material for durability
- Sleep mode
- 8-hour off timer
- Equipped with cut-off safety device
- Blade safety plate & Safety wire adopted
- Color: ○White or ●Silver

- 溫度感應器
- LED燈
- 1/2 自然韻律風功能
- 五段風速調節
- LCD無線遙控器
- 3D扇葉設計提供強力流暢送風
- 扇葉採用 PPG耐用物料
- 睡眠模式
- 八小時電子時間掣
- 安全斷電掣
- 備有扇葉防護裝置及安全鋼線
- 顏色: ○白色或 ●銀色



R48SP

120cm (48")

SAFETY
130430-11

- Wireless remote controller
- 3-speed control with sleep mode
- 1, 3, 6 hour off timer
- PPG blade material for durability
- Equipped with cut-off safety device, blade safety plate and safety wire

- 無線遙遠控制
- 三段風速調節, 備有睡眠模式
- 六小時電子時間掣
- 扇葉採用 PPG耐用物料
- 備有安全斷電掣、扇葉防護裝置及安全鋼線



Z60WS

150cm (60")

1/2 yuragi

SAFETY
141718-12

- 7 speed
- LCD wireless remote control
- 1/2 Yuragi function
- 3D blade delivers smooth and strong airflow
- PPG blade material for durability
- Sleep mode
- 8-hour off timer
- Equipped with cut-off safety device
- Blade safety plate & Safety wire adopted
- Color: ○White or ●Silver Gray

- 7段風速調節
- LCD無線遙遠控制
- 1/2 自然韻律風功能
- 3D扇葉設計提供強力流暢送風
- 扇葉採用 PPG耐用物料
- 睡眠模式
- 八小時電子時間掣
- 安全斷電掣
- 備有扇葉防護裝置及安全鋼線
- 顏色: ○白色或 ●銀灰色



M11SU

110cm (44")

SAFETY
140872-11

- Wireless remote controller
- 3-speed selection
- 1, 3, 6 hours timer
- Sleep mode
- ABS blade material
- Equipped with cut-off safety device, blade safety plate and safety wire
- Color: ○White or ●Silver

- 無線遙控器
- 3段風速調節
- 六小時時間掣
- 睡眠模式
- 扇葉採用 ABS 耐用塑料
- 備有安全斷電掣、扇葉防護裝置及安全鋼線
- 顏色: ○白色或 ●銀色



Remote Control
無線遙控器

○ White

● Platinum Silver

M56SR

140cm (56")



101598-11

- Wireless remote controller
- 3-speed selection
- 1,3,6 hours timer
- Sleep mode
- Thermal fuse prevent overheating or power surge
- Safety wire provided and cut-off safety switch provided
- Fall prevention of blade adopted
- Permanently lubricated ball-bearing assembly
- Color: ○ White or ● Platinum Silver

- 無線遙控器
- 3段風速調節
- 六小時時間掣
- 睡眠模式
- 熱敏斷路器防止過熱
- 備有安全鋼線及安全掣
- 防止扇葉脫下
- 永久潤滑滾珠式軸承組件
- 顏色: ○白色或 ●鉑銀色

CEILING FAN 吊扇

REGULATOR CONTROL TYPE 控制開關系列



○ White

● Black

5-speed
Regulator
5段風速
調節器

M48SG / M48WG

120cm (48")



101595-11



101596-11

M60SG / M60WG

150cm (60")



101599-11



101594-11

- Compact size condenser controlled regulator
- 5-speed selection
- Thermal fuse prevent overheating
- Safety wire and cut-off safety switch provided
- Fall prevention of blade adopted
- Permanently lubricated ball-bearing assembly
- Color: ● Black or ○ White

- 纖巧電容控制調節器
- 5段風速調節
- 熱敏斷路器防止過熱
- 備有安全鋼線及安全掣
- 防止扇葉脫下
- 永久潤滑滾珠式軸承組件
- 顏色: ●黑色或 ○白色

規格 SPECIFICATION

| Model 型號 | 230V (伏特), 50Hz (赫茲) | | | | | | | |
|----------|----------------------|--------|-----------|--------|-------------------|-----------------|--------------------------------|---------------------------------|
| | Wattage 瓦 | | RPM 每分鐘轉數 | | Air Velocity 送風速度 | | Air Delivery 送風範圍 | |
| | Low 低 | High 高 | Low 低 | High 高 | m/min. 米/分鐘 | ft/min. 呎/分鐘 | m ³ /min. 立方米/分鐘 | ft ³ /min. 立方呎/分鐘 |

Living Fan 優美扇

| | | | | | | | | |
|-------|---------|---------|-----------|---------------|-----|-----|----|-------|
| N30NH | 21 - 27 | 37 - 46 | 665 - 845 | 980 - 1,190 | 184 | 603 | 42 | 1,483 |
| P30KH | 21 - 26 | 37 - 40 | 785 - 965 | 1,020 - 1,250 | 209 | 686 | 55 | 1,942 |
| N40HS | 38 - 47 | 47 - 58 | 765 - 935 | 1,060 - 1,295 | 265 | 869 | 82 | 2,895 |
| M40KS | 40 - 49 | 49 - 59 | 808 - 987 | 1,076 - 1,316 | 272 | 892 | 92 | 3,249 |
| PL30H | 28 | 38 | 730 | 1,050 | 202 | 663 | 44 | 1,554 |

Pedestal Fan 座地扇

| | | | | | | | | |
|-------|---------|-------------|-----------|---------------|-----|-----|----|-------|
| P40US | 36 - 44 | 47.5 - 54.5 | 818 - 999 | 1,093 - 1,336 | 250 | 820 | 81 | 2,860 |
| P40VS | 36 - 44 | 47.5 - 54.5 | 818 - 999 | 1,093 - 1,336 | 250 | 820 | 81 | 2,860 |

Box Fan 行運扇

| | | | | | | | | |
|-------|-------------|-------------|-----------|-------------|-----|-----|------|-------|
| ST30H | 28.2 - 34.4 | 37.5 - 45.9 | 698 - 854 | 997 - 1,219 | 220 | 721 | 50.5 | 1,783 |
| SD30H | 28.2 - 34.4 | 37.5 - 45.9 | 698 - 854 | 997 - 1,219 | 220 | 721 | 50.5 | 1,783 |
| SS30H | 28.2 - 34.4 | 37.5 - 45.9 | 698 - 854 | 997 - 1,219 | 220 | 721 | 50.5 | 1,783 |
| SC30H | 28.2 - 34.4 | 37.5 - 45.9 | 698 - 854 | 997 - 1,219 | 220 | 721 | 50.5 | 1,783 |

Desk Fan 座檯扇

| | | | | | | | | |
|-------|---------|-----------|-------------|---------------|-----|-----|----|-------|
| A30AS | 24 - 29 | 33 - 38 | 828 - 1,013 | 1,101 - 1,346 | 210 | 689 | 42 | 1,483 |
| A40AS | 38 - 46 | 48 - 54.5 | 765 - 935 | 1,060 - 1,295 | 246 | 807 | 80 | 2,825 |

Orbital Fan 樓底扇

| | | | | | | | | |
|-------|---------|-------------|-----------|---------------|-----|-----|----|-------|
| M40RS | 23 - 28 | 47.5 - 54.5 | 690 - 850 | 1,080 - 1,320 | 256 | 840 | 79 | 2,790 |
|-------|---------|-------------|-----------|---------------|-----|-----|----|-------|

Wall Fan 掛牆扇

| | | | | | | | | |
|-------|---------|-------------|-----------|---------------|-----|-----|----|-------|
| M30CS | 26 - 32 | 33 - 38 | 779 - 952 | 1,124 - 1,374 | 215 | 705 | 45 | 1,589 |
| M40CS | 36 - 44 | 47.5 - 54.5 | 818 - 999 | 1,093 - 1,336 | 250 | 820 | 81 | 2,860 |
| M40MS | 40 - 49 | 51 - 57.5 | 808 - 987 | 1,076 - 1,316 | 247 | 810 | 84 | 2,966 |

Ceiling Fan 吊扇

Dc Motor Type 直流馬達系列

| | | | | | | | | |
|-------|---|-----|----|-----|-----|-----|-----|-------|
| T60AW | 3 | 39 | 80 | 230 | 205 | 673 | 240 | 8,476 |
| T60DW | 3 | 39 | 80 | 230 | 205 | 673 | 240 | 8,476 |
| W56WW | 3 | 39 | 80 | 228 | 180 | 591 | 220 | 7,769 |
| U60FW | 3 | 39* | 80 | 230 | 205 | 673 | 240 | 8,476 |
| U48FP | 3 | 27* | 80 | 235 | 180 | 590 | 182 | 6,427 |

Wireless Remote Control Type 無線遙控系列

| | | | | | | | | |
|-------|----|----|-----|-----|-----|-----|-----|-------|
| V56VK | 20 | 77 | 89 | 195 | 180 | 591 | 220 | 7,769 |
| Z60WS | 24 | 87 | 86 | 192 | 201 | 660 | 235 | 8,299 |
| R48SP | - | 60 | 194 | 237 | 175 | 574 | 170 | 6,003 |
| M11SU | 20 | 54 | 119 | 190 | 190 | 624 | 160 | 5,650 |
| M56SR | 18 | 64 | 92 | 190 | 155 | 509 | 190 | 6,710 |

Regulator Control Type 控制開關系列

| | | | | | | | | |
|-------|----|----|-----|-----|-----|-----|-----|-------|
| M48SG | 16 | 49 | 146 | 296 | 165 | 542 | 160 | 5,650 |
| M48WG | 16 | 49 | 146 | 296 | 165 | 542 | 160 | 5,650 |
| M60SG | 16 | 71 | 97 | 233 | 160 | 525 | 225 | 7,945 |
| M60WG | 16 | 71 | 97 | 233 | 160 | 525 | 225 | 7,945 |