

External Dimensions

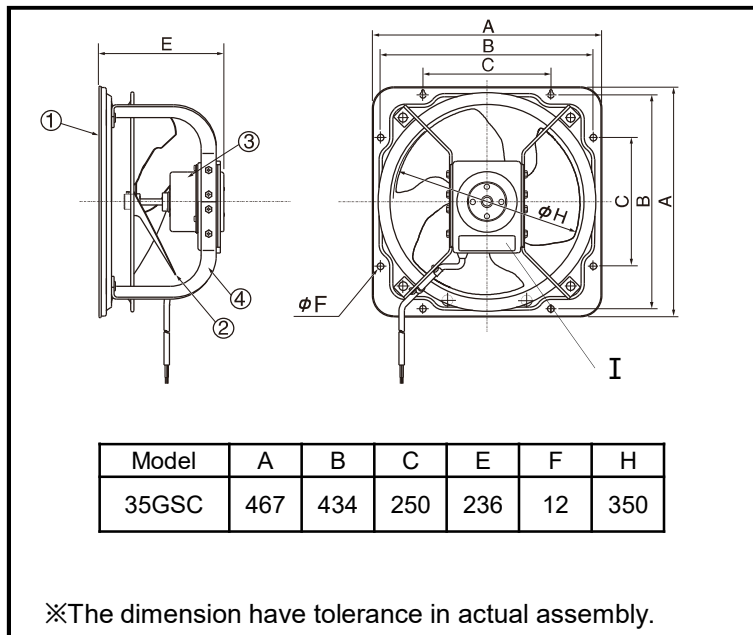

Unit: mm

Labeling Position

Mark	Item	Comment
I	NAME PLATE	-

Component Parts List

Main Parts List

Mark	Part Name	Material	Quantity
①	Frame	Metal	1
②	Blade	Metal	1
③	Motor	Metal	-
④	Motor Support	Metal	4

Accessory List

Item	Quantity	comment
Operating instruction	1	-
Assembling instruction	1	For separated package

Authentication Information

认证种类 (测试机构等) IEC (TUV)

Product		Page	
Ventilating Fan		1/5	
Model		35GSC	
Make Date	2022.04.11	Scale	Drawing No.
Modification Date			HPVF22006
		Modification No.	
KDK Company, Division of PES			



■ Specification Data (35GSC 220~240V 50Hz)

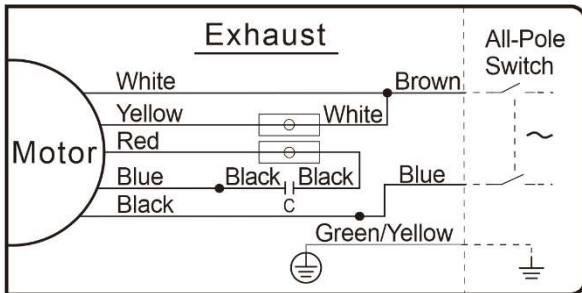
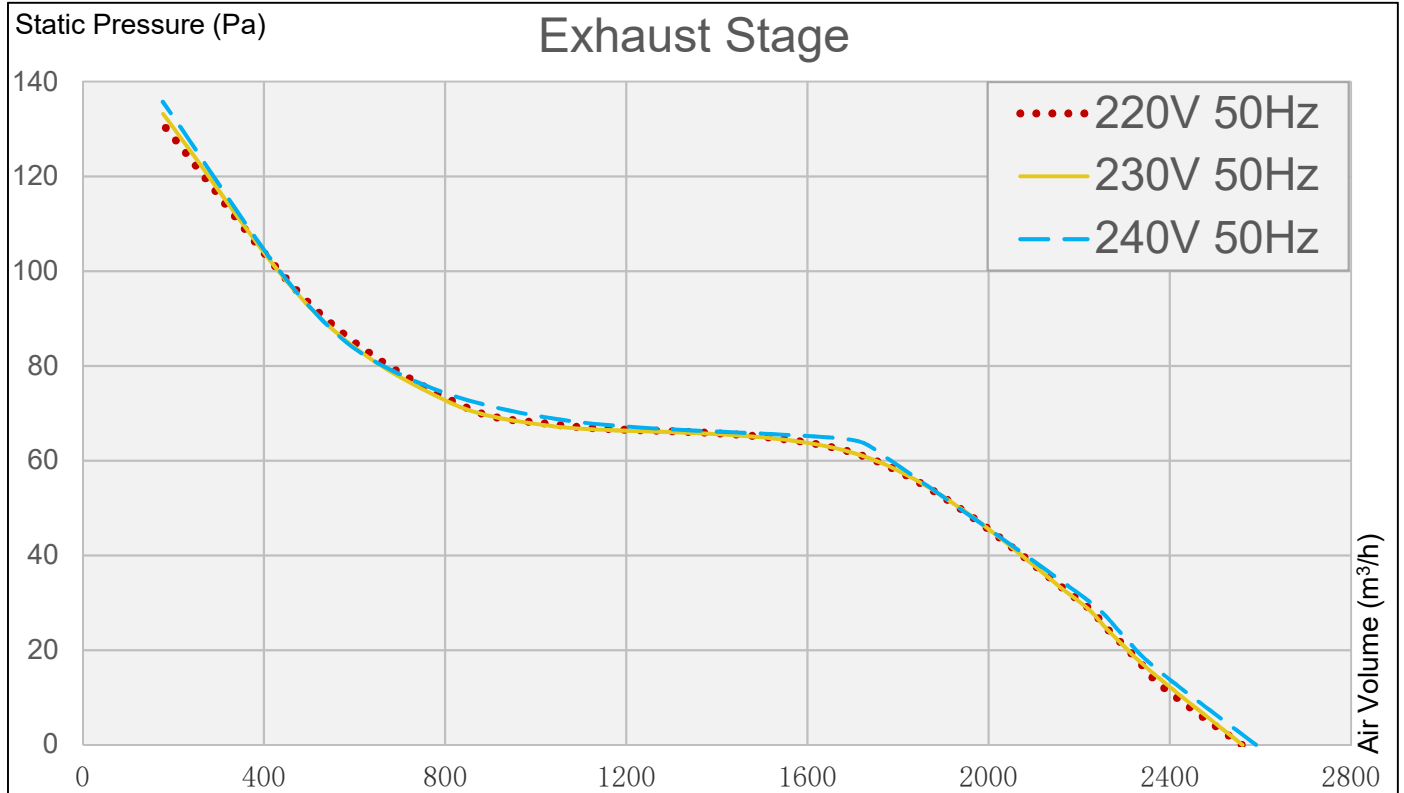

■ Air volume, electric specification and noise value are measured when static pressure is 0 Pa.

■ Noise value is the weighted sound pressure grade A, which is the central value measured by this company, its tolerance range is from +3 to -7. The method to measure is as follows: in an anechoic chamber, measure noise value first 1m away from the left, right and center of the sample, then get the averaged value.

■ Air volume is the central value measured by this company with $\pm 10\%$ of tolerance range.

MODEL	35GSC		
	Exhaust Stage		
Rated Voltage (V)	220	230	240
Rated Frequency (Hz)	50	50	50
Power Consumption (W)	88	91	95
Air Volume (m ³ /h)	2560	2560	2590
Noise (dB)	43.5	43.5	47.5
Net Weight (kg)	10.5		
Motor Type	AC Motor (Class E)		
Operating Temperature	-10°C~50°C		
Insulation Resistance	>10MΩ		
Electric Strength	AC1500V/1 minute		
Ventilation Hole Size	395mm*395mm		

Product			Page	2/5
Ventilating Fan			Model	
			35GSC	
Make Date	2022.04.11	Scale	Drawing No.	HPVF22006
Modification Date			Modification No.	
KDK Company, Division of PES.				

■ Specification Data (35GSC 220~230V 60Hz)

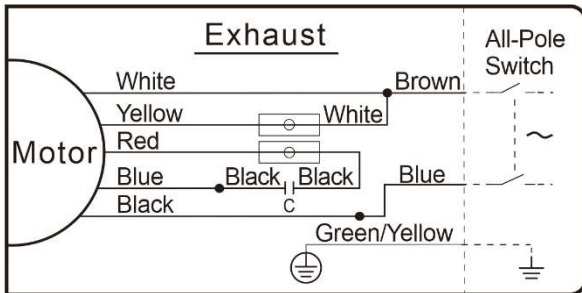
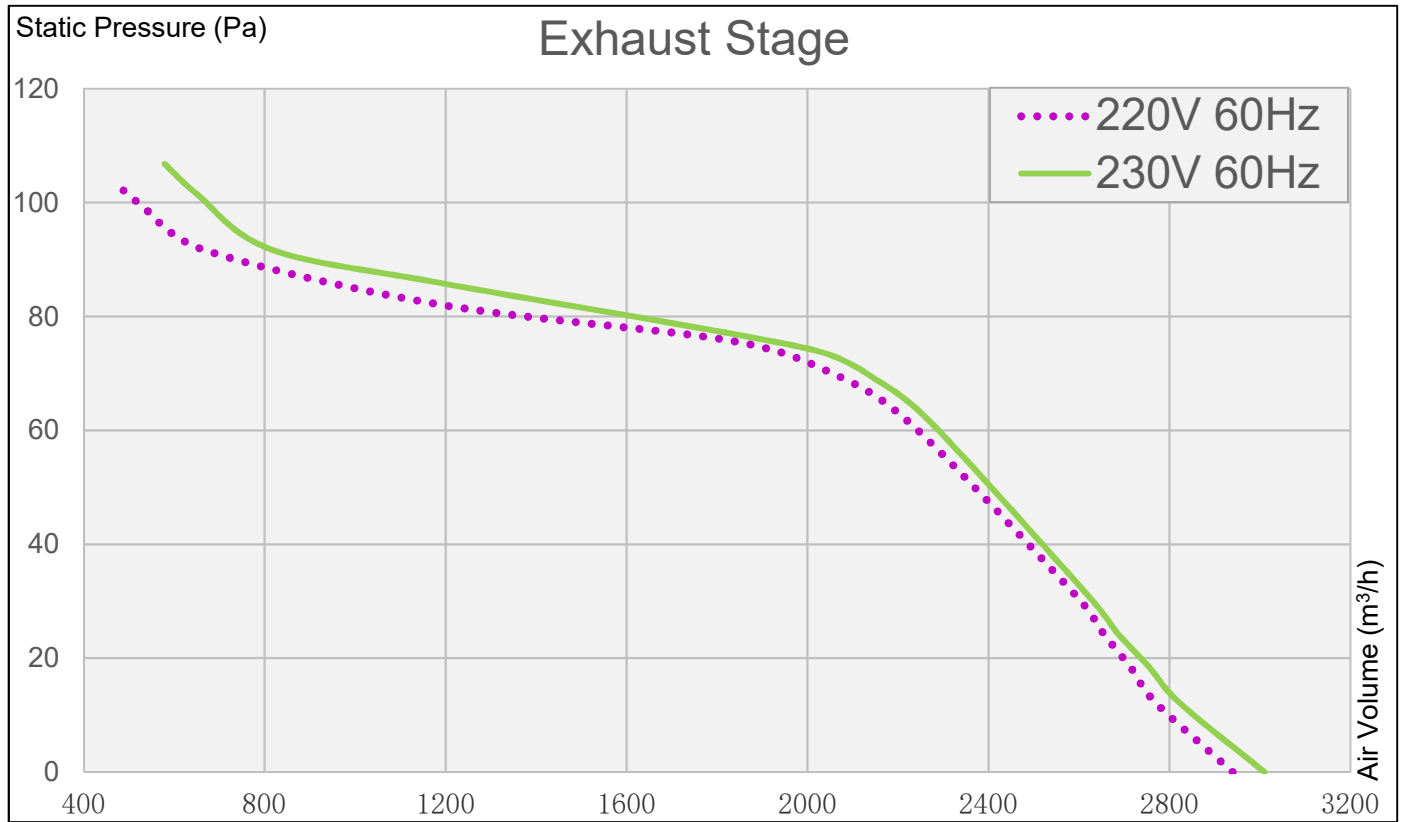

MODEL	35GSC	
	Exhaust Stage	
Rated Voltage (V)	220	230
Rated Frequency (Hz)	60	60
Power Consumption (W)	127	130
Air Volume (m³/h)	2940	3010
Noise (dB)	47.5	47.5
Net Weight (kg)	10.5	
Motor Type	AC Motor (Class E)	
Operating Temperature	-10°C~50°C	
Insulation Resistance	>10MΩ	
Electric Strength	AC1500V/1 minute	
Ventilation Hole Size	395mm*395mm	

■ Air volume, electric specification and noise value are measured when static pressure is 0 Pa.

■ Noise value is the weighted sound pressure grade A, which is the central value measured by this company, its tolerance range is from +3 to -7. The method to measure is as follows: in an anechoic chamber, measure noise value first 1m away from the left, right and center of the sample, then get the averaged value.

■ Air volume is the central value measured by this company with ±10% of tolerance range.

Product			Page	3/5
Ventilating Fan			Model	
			35GSC	
Make Date	2022.04.11	Scale	Drawing No.	HPVF22006
Modification Date			Modification No.	
KDK Company, Division of PES				

■ Specification Data (35GSC 110~127V 50Hz)

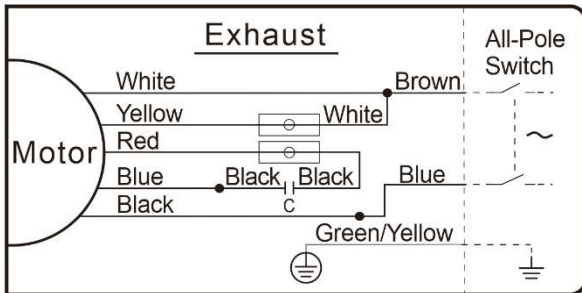
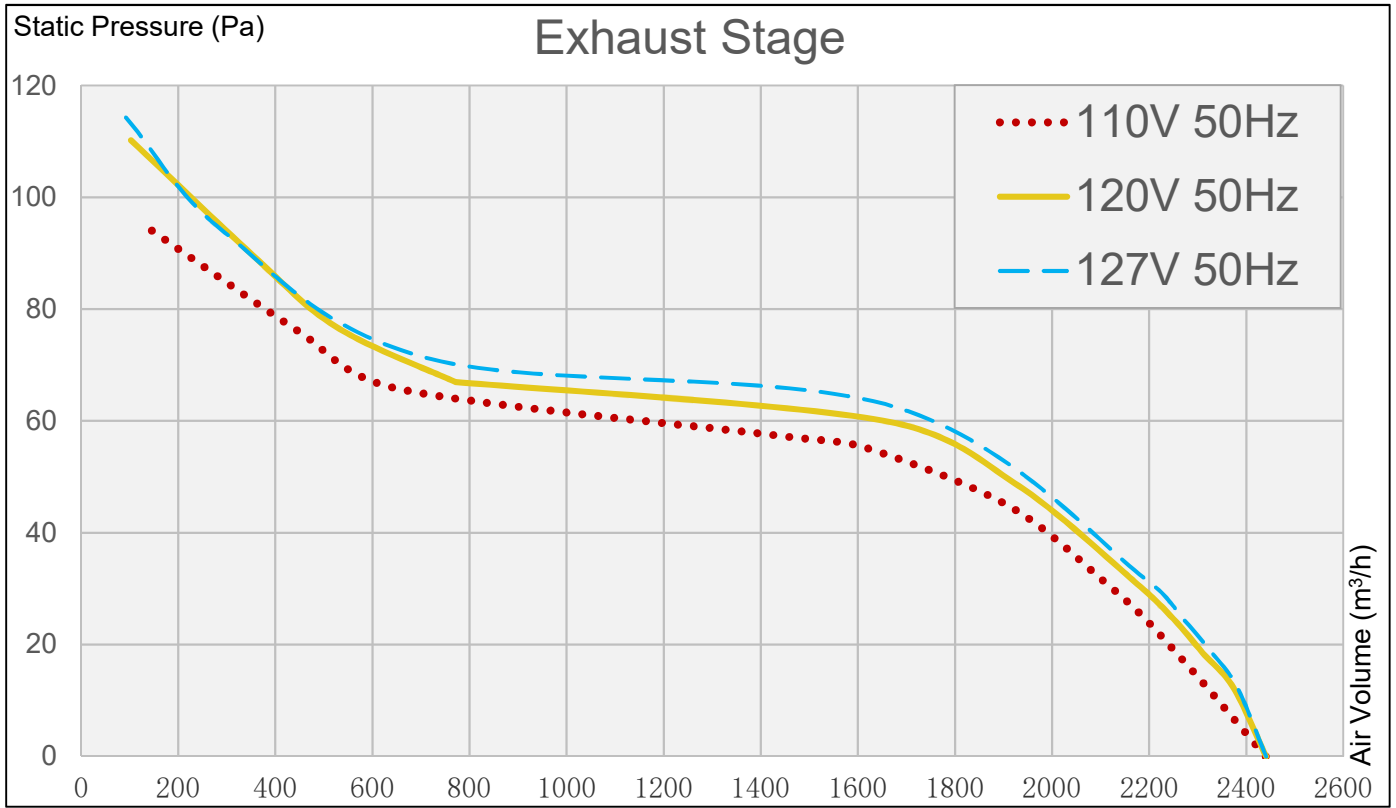

■ Air volume, electric specification and noise value are measured when static pressure is 0 Pa.

■ Noise value is the weighted sound pressure grade A, which is the central value measured by this company, its tolerance range is from +3 to -7. The method to measure is as follows: in an anechoic chamber, measure noise value first 1m away from the left, right and center of the sample, then get the averaged value.

■ Air volume is the central value measured by this company with $\pm 10\%$ of tolerance range.

MODEL	35GSC		
	Exhaust Stage		
Rated Voltage (V)	110	120	127
Rated Frequency (Hz)	50	50	50
Power Consumption (W)	80	86	92
Air Volume (m ³ /h)	2440	2440	2440
Noise (dB)	43	43	43.2
Net Weight (kg)	10.5		
Motor Type	AC Motor (Class E)		
Operating Temperature	-10°C~50°C		
Insulation Resistance	>10MΩ		
Electric Strength	AC1500V/1 minute		
Ventilation Hole Size	395mm*395mm		

Product			Page	4/5
Ventilating Fan			Model	
			35GSC	
Make Date	2022.04.11	Scale	Drawing No.	HPVF22006
Modification Date			Modification No.	
KDK Company, Division of PES				

■ Specification Data (35GSC 110~127V 60Hz)

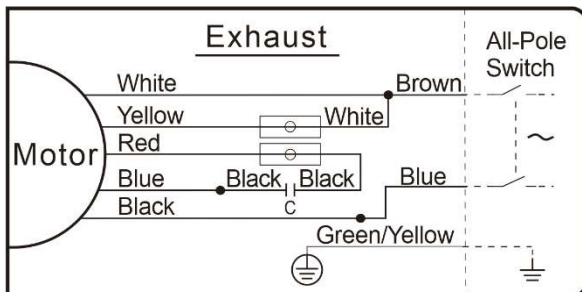
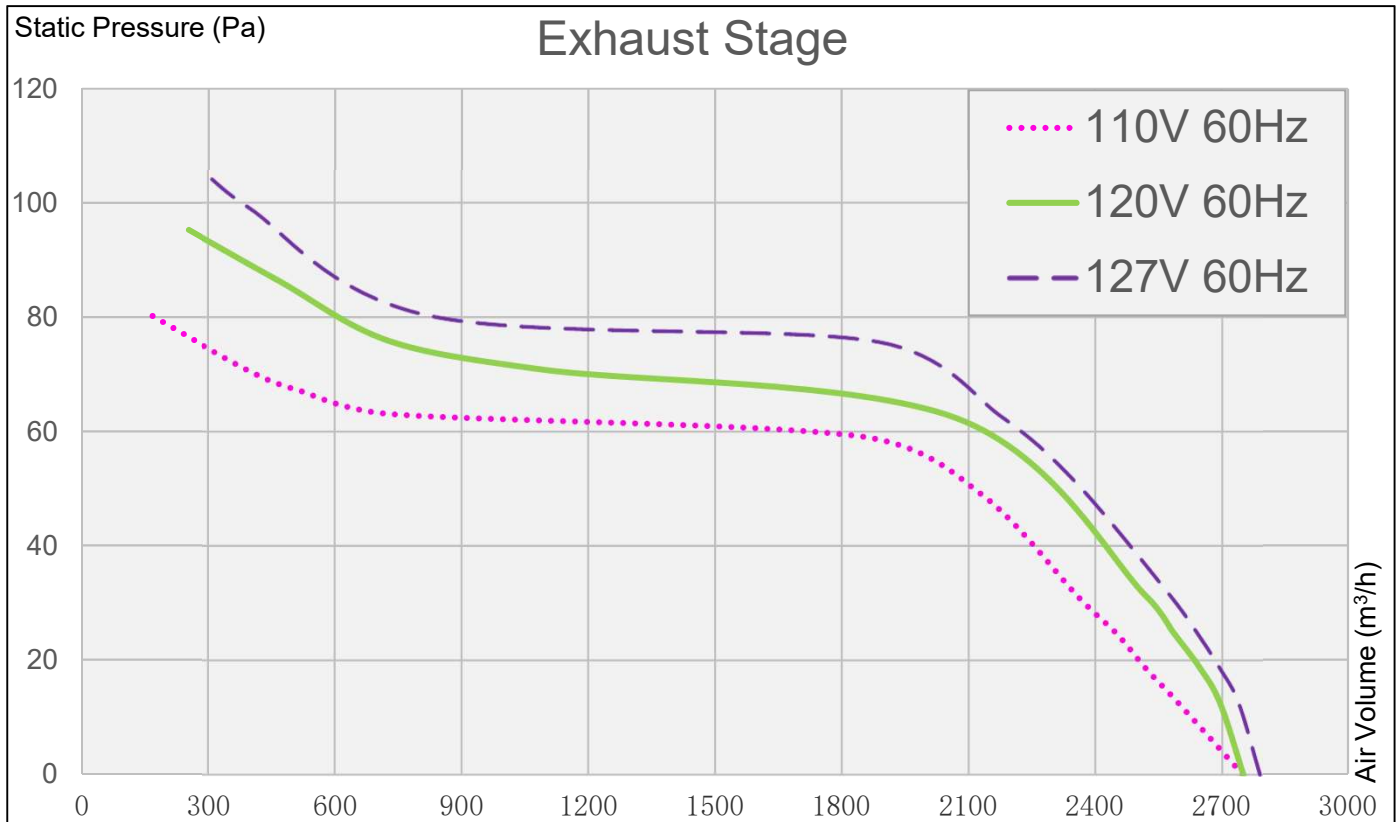

MODEL	35GSC		
	Exhaust Stage		
Rated Voltage (V)	110	120	127
Rated Frequency (Hz)	60	60	60
Power Consumption (W)	111	115	120
Air Volume (m³/h)	2750	2750	2790
Noise (dB)	47	47	47.2
Net Weight (kg)	10.5		
Motor Type	AC Motor (Class E)		
Operating Temperature	-10°C~50°C		
Insulation Resistance	>10MΩ		
Electric Strength	AC1500V/1 minute		
Ventilation Hole Size	395mm*395mm		

■ Air volume, electric specification and noise value are measured when static pressure is 0 Pa.

■ Noise value is the weighted sound pressure grade A, which is the central value measured by this company, its tolerance range is from +3 to -7. The method to measure is as follows: in an anechoic chamber, measure noise value first 1m away from the left, right and center of the sample, then get the averaged value.

■ Air volume is the central value measured by this company with ±10% of tolerance range.

Product			Page	5/5
Ventilating Fan			Model	
2022.04.11			35GSC	
Make Date	2022.04.11	Scale	Drawing No.	HPVF22006
Modification Date			Modification No.	
KDK Company, Division of PES				