



# OPERATING INSTALLATION INSTRUCTIONS

## Petunjuk Pemasangan dan pemakaian

### 使用安裝說明書

**MODEL**

**MODEL**

型號

20AUH	20RGF	20ALH	20RLF
25AUH	25RGF	25ALH	25RLF
30AUH	30RGF	30ALF	30RLE

Please read these instructions carefully before attempting to install, operate or service the Ventilating Fan. Failure to comply with instructions could result injury and/or property damage. In that case the product shall not warrant them. Please retain this booklet for future reference.

Silakan baca baca petunjuk ini sebelum pemasangan. Mengoperasikan kipas angin hisap tanpa mengikuti petunjuk mungkin menyebabkan hal yang tidak diinginkan ataupun kerusakan pada unit. Dalam Kasus tersebut, kerusakan tidak dijamin. garansi. Silakan simpan Buku petunjuk ini untuk referensi dikemudian hari

安裝、使用和維護換氣扇前，請仔細閱讀本說明書。不遵照此說明書進行操作有可能導致人員受傷和／或財產損失。如果發生以上情況，生產廠家將不對其負任何責任。請妥善保管好此說明書以備日後參考。



The following explanations must always be observed in order to prevent harm to users or other people and prevent damage to property.

Penjelasan berikut ini harap dipelajari dengan hati-hati agar Tidak Terjadi sesuatu yang tidak diinginkan kan  
為避免給您及其他人造成傷害，這裏我們列出了以下安全注意事項，請務必遵守各種標誌的含義請參見以下內容：

- The following displays are classified and explained to what extent harm or damage occurs when the display details are ignored and the unit in question is wrongly used.  
tanda gambar berikut menjelaskan Seberapa serious bahaya yang diakibatkan bila Tidak mematuhi petunjuk yang ada  
無視或錯誤理解這些標誌會產生下列兩種情況。

	<b>Warning</b> <b>Peringatan</b> <b>警告</b>	This indication means: Must be treated seriously that this may result in death or serious injury. Tanda ini menunjukkan bahwa harus dilaksanakan dengan karena bila tidak dapat menyebabkan kecelakaan besau kemation 本標誌所表示的內容為“可能造成人員重傷或傷亡”。
-----------------------------------------------------------------------------------	--------------------------------------------------	------------------------------------------------------------------------------------------------------------------------------------------------------------------------------------------------------------------------------------------------------

- The types of details to be observed are classified and explained in the following illustrated display. (Below are the series of illustrated displays)  
Selanjutnya tanda gambar berikut ini menjelaskan hal sebagai berikut  
務必遵守的內容分類，用標誌區分說明如下：

	This type of pictorial symbol indicates a "Prohibited" action that must be avoided. Tanda gambar ini menjelaskan suatu tindakan yang dilarang dan untuk dilakukan 此標誌表示為禁止事項
	This type of pictorial symbol indicates a "Compulsory" action that must be performed. Tanda gambar ini menjelaskan suatu tindakan yang harus dilakukan 此標誌表示強制事項

		<b>Warning</b> <b>Peringatan</b> <b>警告</b>	
■ The unit should be grounded Unit ini harus diberi Ground/ massa 本產品必須接地		■ Must not disassemble the unit for reconstruction. Unit ini tidak boleh dibongkar pasang 禁止拆開本產品進行改造。	
■ Use this fan at the rated voltage and frequency indicated on the name plate. Gunakan unit ini pada voltase dan frekuensi yang telah ditentukan 按照銘牌標定的額定電壓及頻率使用本產品		It may cause fire or electric shock Depat menyebabkan kanslet atau 容易導致火災、觸電	Repairing should be serviced by authorized service centre. Perbaikan harus dilakukan oleh service centre resmi 修理時必須到指定的維修店進行修理

## Peringatan Saat Pemasangan



Warning 警告  
Peringatan



- This appliance is not intended for use by persons (including children) with reduced physical, sensory or mental capabilities, or lack of experience and knowledge, unless they have been given supervision or instruction concerning use of the appliance by a person responsible for their safety. Children should be supervised to ensure that they do not play with the appliance.

Unit ini tidak diperkenankan dioperasikan oleh anak-anak atau orang cacat atau yang tidak berpengalaman kecuali mereka telah dilatih atau mendapat pengawasan yang memadai

本產品不適合有殘障、智障或精神障礙的人士，或缺乏經驗、常識者(包括兒童)維護使用，除非在監護人的看護或指導下使用。應確保兒童不要把本產品當作玩具玩。



Caution 注意  
Perhatian

- Prohibit to install this fan where it could be directly exposed to water or excess vapor. Dilarang memasang unit ini yang terkena air langsung atau embun yang berlebih

禁止將換氣扇安裝在容易被水噴到或煙霧，水汽過多的地方，可能會引起短路和觸電。

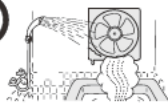

- Prohibit to install this fan in the ceiling. Dilarang menaruh unit ini di langit-langit atau plafon

禁止將本換氣扇裝在天花板上，有落下的危險。

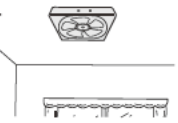

- Prohibit to install this fan over cooking equipment. Dilarang memasang unit ini dekat kompor

禁止將本換氣扇裝在烹調設備上方。

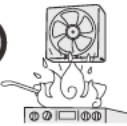

- Be sure to provide an appropriate opening for air intake. Pastikan ada aliran udara masuk yang cukup memadai

安裝場所必須設置有通風口。

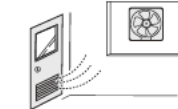

- This fan can be mounted in outside walls from inside of room. Unit ini dapat dipasang pada dinding-dinding bagian luar dari dalam ruangan  
此換氣扇可以從室內安裝在外牆上。



- This fan should be installed so that the blades are more than 2.3m above the floor. Malaysia market: This fan should be installed so that the blades are more than 2.5m above the floor. Unit ini harus dipasang pada ketinggian minimum 2.3 meter dari lantai  
Untuk Pasar Malaysia ketinggian minimum adalah 2.5 M  
安裝之後，本產品的扇葉至地面距離不得少於2.3m。  
馬來西亞市場：安裝之後，本產品的扇葉至地面距離不得少於2.5m



- Product must be installed on to the wall which is enough strong, if the wall is not enough strong it must be reinforced for it to be strong enough. Produk haru dipasang pada dinding yang kuat. Jika Dinding tidak kuat, harus diperkuat agar cukup kuat  
產品必須安裝在足夠牢固的牆上，如果牆體不牢固，必須對其進行加固



- For this fan, precautions must be taken to avoid the back-flow of gases into the room from the open-flue of gas or other fuel-burning appliances. Harap hati-hati dengan arus angin atau api yang menendang balik, yang disebabkan oleh saluran ducting pada bagian luar yang dekat dengan udara atau gas yang mudah terbakar.  
在安裝換氣扇時，請採取適當的措施以防止氣體從一般的排氣管或炊具排氣管倒流回室內。



- This fan should be installed so that the metal parts of the product and mounting screw do not contact any metallic members in the wall, such as metal laths, wire laths and metal plate, it is possible to cause fire hazards in case of leak. Unit kipas harus dipasang sehingga bagian metal atau dudukan tidak terkena langsung logam pada tembok. Dapat menyebabkan bahaya kebakaran dalam kasus kebocoran  
本產品在安裝時，安裝螺釘等金屬部件禁止借助於牆壁中的金屬條、線槽或金屬板等金屬部件材料進行接地，以防止發生漏電現象而導致火災。

## Peringatan Saat Pemasangan



Caution      注意  
Perhatian

- Use a device for disconnection from the supply, having a contact separation of at least 3mm in all poles in accordance with the wiring rule.  
Gunakan saklar atau switch untuk memutuskan aliran listrik, dimana terdapat jarak minimum 3 mm antara switch tersebut. Pemasangan ini dapat disesuaikan dengan ketentuan setempat.  
安裝時，必需在供電線路中安裝其觸點開距不少於3mm的全極斷開裝置。
- This fan must be installed by a qualified technician. Otherwise, it is possible to be dropped down.  
Unit ini harus dipasang oleh teknisi yang berpengalaman, bila tidak unit ini dapat jatuh.  
此換氣扇必須由專職人員按安裝方法進行安裝，否則有落下的危險。

## HOW TO INSTALL Cara Pemasangan

## 安裝方法

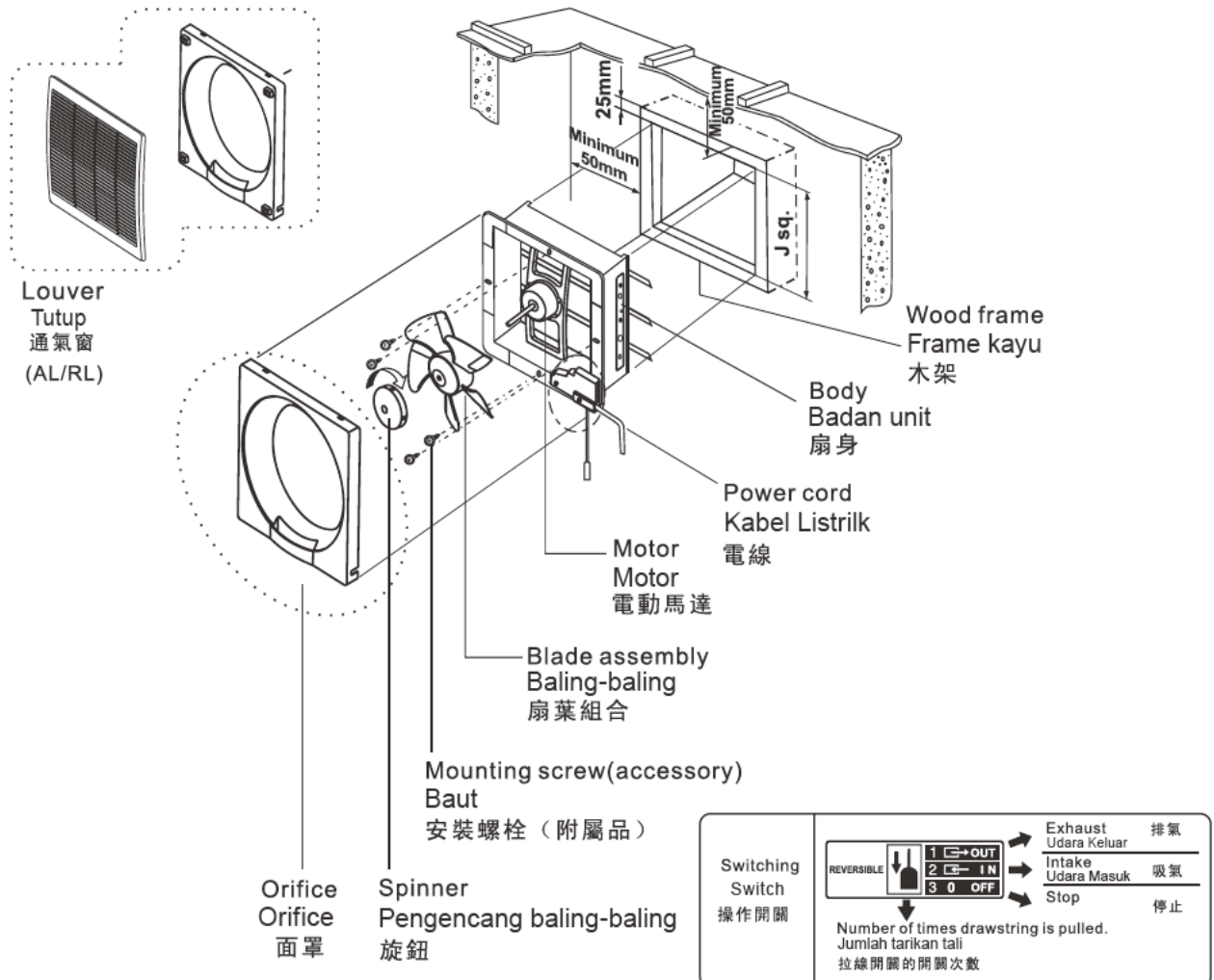

## Cara Pemasangan

Unit : mm.

Model Model 型號	A	B	C	D	E	F	G	H	J
20AU/RG	200	306	260	302	240	52	90	80	250
25AU/RG	250	356	310	352	290	38	90	63	300
30AU/RG	300	406	360	402	340	38	90	78	350
20AL/RL	200	306	260	302	240	68	90	80	250
25AL/RL	250	356	310	352	290	63	90	63	300
30AL/RL	300	406	360	402	340	63	90	78	350

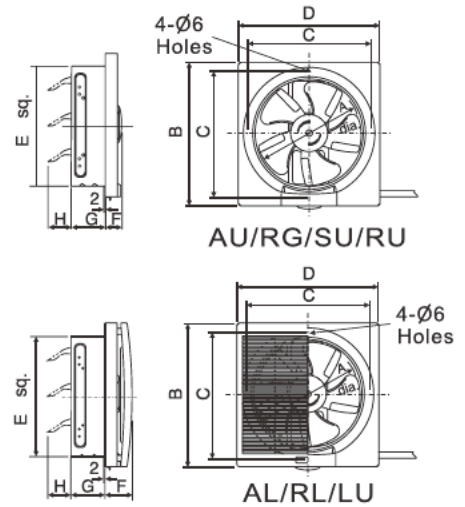

Connect the power cord to the power supply line according to the wiring diagram and the local electrical wiring rules of fixed wiring.  
 Hubungkan kabel unit ke jaringan listrik sesuai dengan diagram kabel yang digambarkan dalam buku petunjuk  
 根據電氣原理圖和當地電氣配線法規中關於固定接線的規定，將電源線連接到供電線路中。

- Make sure all connections are fastend firmly after wiring is finished.  
 Pastikan semua sambungan kabel telah ditutup dengan baik  
 在電源線連接完成後請確保所有連接都已牢固地固定。
- It is required to use terminal (not included) that complies IEC 60998.  
 Disarankan untuk menggunakan terminal (tidak termasuk) yang sesuai dengan IEC60998  
 要求使用符合IEC60998的接線端子座（需另購）。
- The all connections should be accommodated in a suitable compartment.  
 Seluruh sambungan sebaiknya ditutup dengan rapih  
 所有的連接必須容納在合適的隔間內。

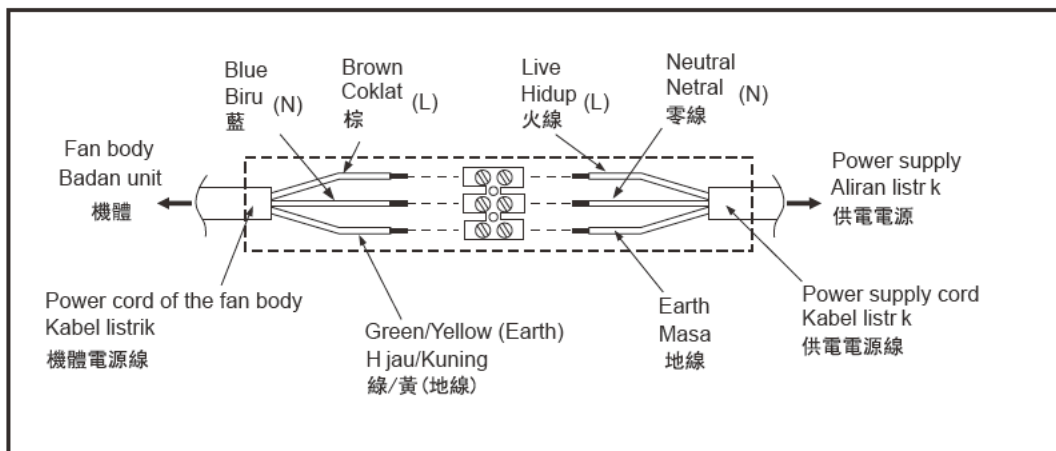

## Hal Penting Yang Harus di Ketahui Dalam Perawatan



Caution  
Perhatian

注意

- Disconnect the power supply until blade is stationary before cleaning and maintenance.  
Putuskan hubungan listrik sampai kipas terhenti secara total sebelum perawatan / membersihkan dimulai  
在清洗保養前請確保斷開電源且扇葉停止轉動。

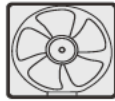

- Never use petrol, benzene, thinner or any other such chemicals for cleaning the ventilating fan.  
jangan gunakan bensin, tinner, atau bahan kimia lainnya untuk membersihkan unit ini  
千萬不要用汽油、苯、溶劑或任何類的化學物清洗這抽氣扇。



- Do not allow water to contact electrical part such as motors or switches  
Jangan sampai alat listrik di unit ini seperti motor dan switch terkena air  
電動馬達或開關制等電氣元件絕對不能被水接觸。

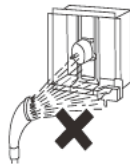

- Do not immerse blade or other resin parts in hot water over 60°C.  
jangan rendam kipas atau bodi plastic lainnya dari unit ini kedalam air panas yang suhunya lebih dari 60°C  
風扇葉等塑膠零件不能用高於60°C的熱水浸洗。

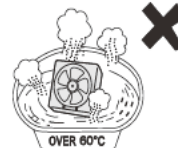

- If the supply cord is damaged, it must be replaced by the manufacturer or its service agent or a similarly qualified person in order to avoid a hazard.  
Jika senar suplai mengalami kerusakan, maka harus diganti oleh pihak pabrik atau servis senter yang ditunjuk untuk mencegah hal yang tidak diinginkan  
如果電源線損壞，為避免危險，必須由製造廠維修部或類似的專職人員來更換。



- When the product is no longer be used, it must not be left in place but removed to prevent it from possibly dropping.  
Bila unit ini tidak dipergunakan, harap disimpan untuk menghindari dari kemungkinan jatuh  
為了避免在萬一的情況下產品掉落，長期不使用本產品時，不得放置不管，而應予以拆除。



- Wear plastic gloves during cleaning may avoid accidents.  
Bila unit ini tidak dihidupkan dalam jangka waktu yang lama, sebaiknya unit ini diturunkan dan disimpan agar tidak terjatuh  
為避免意外發生，清潔時請戴上膠手套。

Wiring Diagram  
Diagrama de cableado

電線接線原理圖

AU/AL

RG/RL

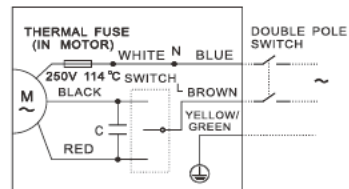
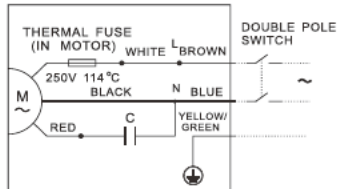

## Spesifikasi

Model Model 型號	Air direction Petunjuk udara 氣流方向	Voltage Voltase 電壓 [V]	Frequency Frekuensi 頻率 [Hz]	Power consumption Konsumsi Daya 耗電量 [W]	Air delivery Pengantaran Daya 排氣量 [m <sup>3</sup> /min]	Power factor Prosentasi Daya 功率因數 [%]	Weight Berat 重量 [kg]
20AUH	Exhaust	220	50	20	9.7	88	2.0
	Exhaust	230	60	25.5	11.8	100	
	Exhaust	240	50	23	10.3	88	
25AUH	Exhaust	220	50	27	15.3	96	2.4
	Exhaust	220	60	31	15.7	98	
	Exhaust	240	50	32	16.0	96	
30AUH	Exhaust	220	50	31	19.2	98	2.7
	Exhaust	220	60	33	19.0	98	
20ALH	Exhaust	220	50	20	9.1	88	2.2
	Exhaust	230	60	25.5	10.5	100	
	Exhaust	240	50	23	9.2	88	
25ALH	Exhaust	220	50	27	13.9	95	2.7
	Exhaust	230	60	40	15	97	
	Exhaust	240	50	32	14.2	94	
30ALF	Exhaust	220	50	31	15.5	98	3.1
	Exhaust	230	60	40	16.7	97	
20RGF	Exhaust	220	50	20	9.7	91	2.1
	Intake			15	6.7	97	
	Exhaust	230	60	25	10.8	99	
	Intake			18	6.7	98	
	Exhaust	240	50	23	10.0	90	
	Intake			17	7.0	97	
25RGF	Exhaust	220	50	27	15.8	91	2.4
	Intake			21	10.0	93	
	Exhaust	230	60	34	15.8	99	
	Intake			24	9.3	95	
	Exhaust	240	50	32	16.0	91	
	Intake			25	10.7	94	
30RGF	Exhaust	220	50	31	19.4	98	2.8
	Intake			24	11.6	100	
	Exhaust	230	60	40	19.2	97	
	Intake			27	12.5	90	
20RLF	Exhaust	220	50	20	9.1	91	2.4
	Intake			15	6.2	97	
	Exhaust	230	60	26	10.0	94	
	Intake			18	6.3	98	
	Exhaust	240	50	23	9.2	90	
	Intake			17	6.5	97	
25RLF	Exhaust	220	50	29	14.0	95	2.7
	Intake			21	9.7	99	
	Exhaust	230	60	40	14.3	97	
	Intake			29	9.7	97	
	Exhaust	240	50	34	14.0	95	
	Intake			25	10.3	99	
30RLE	Exhaust	220	50	31	16.5	98	3.1
	Intake			25	9.9	100	
	Exhaust	230	60	40	16.3	97	
	Intake			27	11.5	98	

Insulation class E IP code:IPX4(outside)  
Instalasi kelas E Kode IP: IPX4(outside)  
E級絶縁 IP號碼: IPX4 (外墙)  
Mã IP E lớp cách điện: IPX4 (phía ngoài)  
Negara Pembuat : Thailand  
Nama Importir : PT. KDK INDONESIA  
Alamat Importir : Gd. Cosa Lt. IV JL. Tomang Raya No. 70, Jakarta 11430

Type of Insulation: Functional Insulation  
Jenis Insulasi: Fungsi Insulasi  
絶縁種類:機能絶縁  
Kiểu cách điện: Cách điện chức năng

KDK Company, Division of PES  
Head Office: 4017, Takaki-cho, Kasugai, Aichi, Japan