

# Operating And Installation Instructions

## 操作和安裝指示

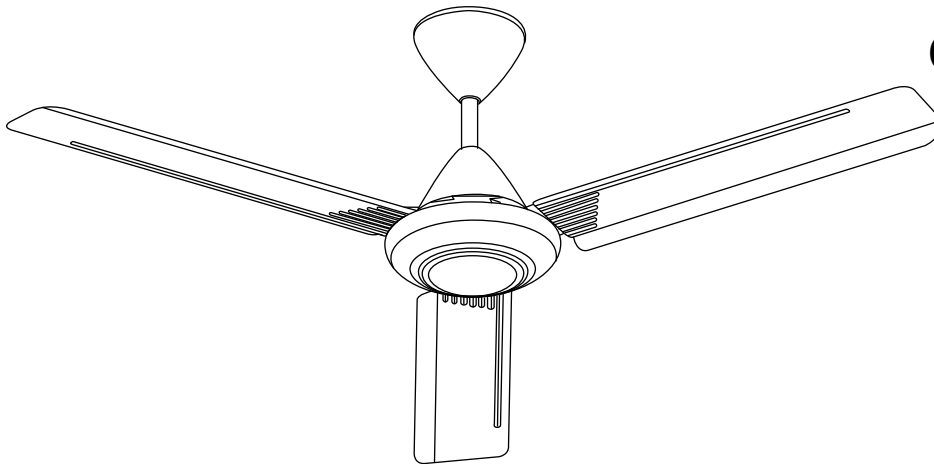

**Ceiling Fan**  
**吊扇**

**Model Number**  
**型號**

**M48SG**  
**M60SG**

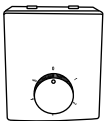

Thank you for purchasing KDK Ceiling Fan  
感謝您購買 KDK 吊扇



Before operating this product, please read the instructions carefully, and keep this manual for future reference.

操作本產品前，請仔細讀本說明書，並保存本說明書以作日後參考。





### Contents / 目錄

Page / 頁數

|                              |    |
|------------------------------|----|
| Safety Precautions / 安全注意事項  | 2  |
| Supplied Parts / 配備零件        | 5  |
| How to Assemble / 如何組裝       | 5  |
| How To Use / 如何使用            | 16 |
| Maintenance / 維修             | 16 |
| Product Specification / 產品規格 | 16 |



# Safety Precautions / 安全注意事項

To avoid the possibility of causing injury to users or damage to properties, please follow all the explanations written below.  
為避免導致用戶受傷或財物損壞的可能性，請遵守以下所述的所有指示。

|   |                      |   |
|---|----------------------|---|
|  | <b>WARNING</b><br>警告 | A state that may be caused by the mishandling of products, which, if not avoided, may lead to the possibility of death or serious injury of users.<br>錯誤操作產品造成情形，若不避免可能導致用戶死亡或嚴重受傷。 |
|  | <b>CAUTION</b><br>注意 | A state that may be caused by the mishandling of products, which, if not avoided, may result in the injury of users or property damage.<br>錯誤操作產品造成情形，若不避免可能導致用戶受傷或財物損失。            |
|  |                      | This symbol denotes an action that is COMPULSORY.<br>此符號表示有關行為是強制性的。  |
|  |                      | This symbol denotes an action that is PROHIBITED.<br>此符號表示有關行為是被禁止的。  |



## WARNING / 警告

|  |   |
|--|---|
|   | <p>Follow strictly to all the instructions given in this manual for installation.<br/>Electrical wiring must be done by competent personnel.<br/>Installation must be done by a qualified personnel.<br/>Installation error can cause fire, electrical shock, Ceiling Fan drops and injuries.<br/>安裝時請嚴格地遵守本手冊內所給的所有指示。<br/>電線配線工作必須由能勝任的人員進行。<br/>安裝工作必須由符合資格的人員進行。<br/>安裝錯誤可以導致火災、電擊、吊扇掉落和受傷。</p> |
|  | <p>Stop using the Ceiling Fan when any abnormality or failure occurs and turn "OFF" the Miniature Circuit Breaker (MCB).<br/>(Risk of smoke, fire, electric shock and drop)<br/>當發生任何異常或故障時，停止使用吊扇並關閉 "OFF" 微型斷路器 (MCB)。<br/>(冒煙、火災、電擊、掉落的風險)</p>   |



## WARNING / 警告

|  |  |   |
|--|--|---|
| <p>Switch off power supply and wait until the Blade is fully static, before cleaning or doing any maintenance jobs.<br/>清掃或進行任何維修工作前，關閉所有電源並等待扇翼完全靜止。</p>  <p>Can cause Ceiling Fan to move suddenly, injuries and electrical shock.<br/>Kindly refer to your sales agent for repairing or maintenance issue.<br/>可以導致吊扇突然轉動、受傷和電擊。<br/>請向您的經銷商諮詢有關修理或維修問題。</p> | <p>Do not dismantle the Ceiling Fan unless stated by this manual.<br/>Must use only supplied parts.<br/>請勿拆除吊扇，除非此說明書指示。<br/>務必只使用附帶的零件。</p>  <p>Can cause fire, electrical shock, Ceiling Fan drops and injuries.<br/>可以導致火災、電擊、吊扇掉落和受傷。</p> | <p>Avoid damage wire during installation eg. Deform due to heat, twist, bend, etc.<br/>避免在安裝時損壞電線，例如因熱量、扭曲、彎曲造成的變形等等。</p>  <p>Can cause fire, explosion, short circuit and electrical shock.<br/>這可導致火災、爆炸、短路及電擊。</p> |
| <p>Ensure the Pipe has been fully tighten to Motor Shaft. (Bolt tightening torque is 800~1200 N•cm) and Cotter Pin must fix into Bolt and bent.<br/>確定將導管鎖緊至發動機轉動軸。(螺栓扭緊轉距是 800~1200 N•cm) 及開口銷必須插入螺栓然後折彎。</p>  <p>Can cause injury if Ceiling Fan drops.<br/>若吊扇掉落會導致受傷。</p>   | <p>Ensure Ceiling Hook can afford more than 10 times the Ceiling Fan weight.<br/>確定天花板鉤子可以承受超過吊扇的 10 倍重量。</p>  <p>Can cause injury if Ceiling Fan drops.<br/>若吊扇掉落會導致受傷。</p>  | <p>Do not sprinkle water to Ceiling Fan. Or, do not wet Ceiling Fan.<br/>切勿向吊扇灑水。或者，切勿弄濕吊扇。</p>   |
| <p>Tighten the Blade Screws firmly using a screwdriver.<br/>使用螺絲起子將扇翼螺絲鎖緊。</p>  <p>Can cause injury if Blade drops.<br/>若扇翼掉落會導致受傷。</p>  | <p>Do not use power supply other than rated voltage mentioned.<br/>切勿使用本文指定的額定電壓以外的電源。</p>  <p>Overheating can cause electrical shock and fire.<br/>過熱可導致電擊和火災。</p>  | <p>Can cause fire, explosion, short circuit and electrical shock.<br/>這可導致火災、爆炸、短路及電擊。</p> <p>Do not install near a flammable area such as a gas cooker.<br/>切勿安裝在煤氣灶等易燃地區附近。</p>                                  |
| <p>Do not touch the Ceiling Fan while it is operating.<br/>請勿在吊扇正在操作的時候觸摸吊扇。</p>  <p>Can cause injury, damage and Ceiling Fan drops.<br/>若吊扇掉落會導致受傷、損壞。</p>   | <p>Do not hang up to the Ceiling Fan.<br/>切勿懸掛在吊扇上。</p>  <p>Can cause Ceiling Fan drops and injuries.<br/>可以導致吊扇掉落和受傷。</p>  |  <p>Can cause fire, explosion, short circuit and electrical shock.<br/>這可導致火災、爆炸、短路和電擊。</p>   |
| <p>Avoid installing the Ceiling Fan at oil and dusty places.<br/>避免將吊扇安裝在油膩及多塵的地方。</p>  <p>Can cause fire, explosion, short circuit and electrical shock.<br/>這可以導致火災、爆炸、短路和電擊。</p>   | <p>Dismantle the broken or damage Ceiling Fan.<br/>拆除破損或損壞了的吊扇。</p>  <p>Can cause Ceiling Fan drops and injuries.<br/>可以導致吊扇掉落和受傷。</p>  |  <p>Do not install near chemicals and alkali.<br/>切勿安裝在化學物品和鹼性物品附近。</p> <p>Can cause fire, explosion, short circuit and electrical shock.<br/>這可以導致火災、爆炸、短路和電擊。</p>   |



## CAUTION / 注意



This appliance is not intended for use by persons (including children) with reduced physical, sensory or mental capabilities, or lack of experience and knowledge, unless they have been given supervision or instruction concerning use of the appliance by a person responsible for their safety. Children should be supervised to ensure that they do not play with the appliance.

除非由安全監護人就本產品進行監督或指導，否則身體、感官或智力有功能障礙者，或者缺乏相關經驗和知識的人士（包括兒童）請勿使用本電器。為了確保年幼的小孩不玩此電器，它們該受到監督。



To avoid the possibility of causing injury to users or damage to properties, please follow all the explanation written in this manual. The manufacturer will not be responsible for any accidents and injuries caused by defective, deficient installation or installation which does not follow to instruction manual.

為避免導致用戶受傷或財物損壞的可能性，請遵守本說明書內的所有指示。製造商對任何因不正確的安裝或不按照說明書指示的安裝所造成的任何意外和損傷將不負任何責任。



## CAUTION / 注意

Ceiling Fan must be mounted above 2.5m from the floor and 1m from the wall to the Blade. Avoid fixing inside the dome ceiling. 吊扇必須掛在離地面 2.5 米以上的高度，而扇翼必須離開牆壁 1 米以上。避免安裝在圓頂天花板。

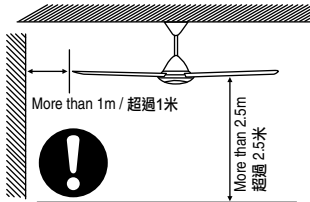

Can cause injury if hit by the Blades.  
Can cause unstable air flow and effect the Ceiling Fan to wobble.  
若被扇翼擊中可導致受傷。  
可以導致不穩定氣流及吊扇搖晃。

Avoid continuous exposure of direct wind from the Ceiling Fan.  
避免長時間讓吊扇直接吹著您。



It may cause discomfort.  
這可能會導致不適。

Do not install at places where there is high vibration and impact.  
切勿安裝在高振動強度和高衝擊強度的地方。

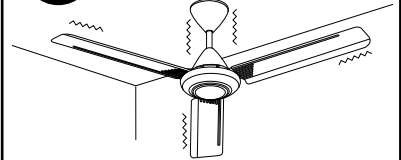

Can cause injury if Ceiling Fan drops.  
若吊扇掉落會導致受傷。

Do not use solvents (Gasoline and petroleum) or any other chemicals. Wipe away dirt with a clean soft cloth, ordinary soap and water to keep the fan clean. 切勿使用溶劑（汽油和石油）或任何其他化學物品。用乾淨的軟布、普通肥皂和水抹去汙跡以保持風扇的清潔。



Can cause plastic part deformation and metal corrosion.  
這可導致塑料部件變形及金屬腐蝕。

Do not install the Ceiling Fan at a wet, high temperature and high humidity area such as shower room.  
切勿將吊扇安裝於潮濕、高溫及高濕度的地方，例如浴室。

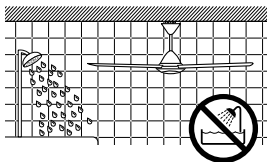

If an electrical current leakage occurs, it can easily cause electrical shock and fire.  
若發生漏電，這很容易會導致電擊和火災。

Replace all the Blades if any of them broken or crack.  
若任何一片扇翼斷了或出現裂痕，請更換所有扇翼。

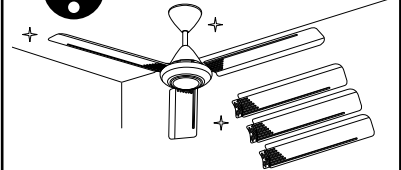

Vibration can cause the Ceiling Fan to fall.  
震動會導致吊扇掉落。

After installation make sure the Ceiling Fan does not wobble extremely.  
安裝完畢後，請確保吊扇不會過度搖晃。

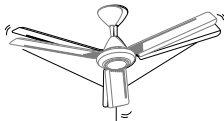

Can cause injury if Ceiling Fan drops.  
若吊扇掉落會導致受傷。

This product is for in house use only. Do not install at a windy places.  
本產品只供室內使用。切勿安裝在多風的地方。



Can cause rusty, discolour, damage and injury.  
這可導致生鏽、褪色、損壞及受傷。

Do not connect the Ceiling Fan to dimmer switch.  
切勿將吊扇連接至調光開關。



Dimmer Switch / 調光開關

It can damage the Ceiling Fan.  
這會損壞吊扇。

# Supplied Parts / 配備零件

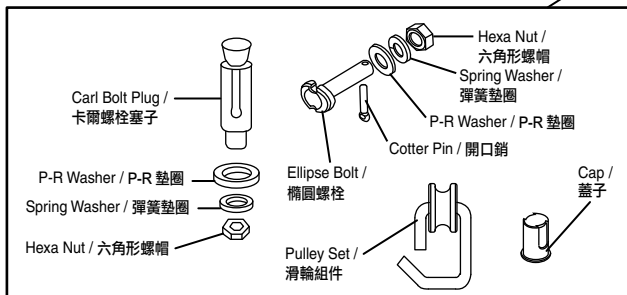
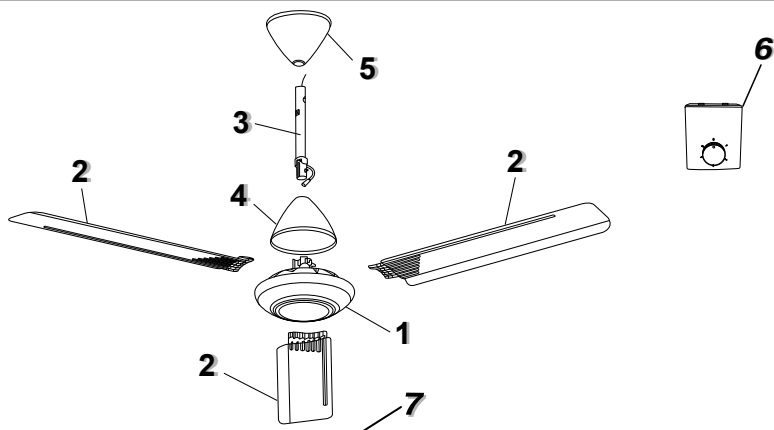

| Parts / 零件                                    | Pcs / 件 |
|---|---------|
| 1. Motor Assembly / 發動機組件                     | 1       |
| 2. Blade Assembly Set / 扇翼組件                  | 3       |
| 3. Pipe / 導管 (9 or 12 or 16 or 18 or 22 inch) | 1       |
| 4. Lower Canopy / 下罩蓋                         | 1       |
| 5. Upper Canopy / 上罩蓋                         | 1       |
| 6. Speed Regulator / 調速器                      | 1       |
| 7. Part Set / 零件組                             | 1       |

## HOOK SET / 吊鉤組

NOTE: These are not supplied.  
注意：這些都不提供。

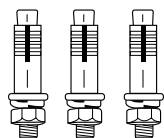

3 Suspension Bolts  
3 個懸掛螺栓

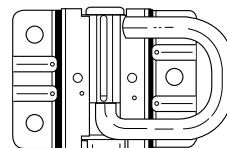

Hook Set  
吊鉤組

## NOTE / 備註

Do not place the Ceiling Fan directly on the floor. / 切勿直接放置吊扇在地板上。  
Can cause scratches to the product. / 這可導致產品被刮花。

# How to Assemble / 如何組裝

## A) Insert the Canopy / 嵌入罩蓋

- 1 Pull out the Safety Wire from Pipe as shown.  
如圖所示將保險線從導管拉出。

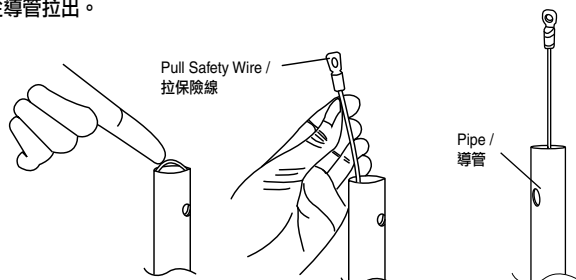

- 2** Insert Lower Canopy to the Pipe. Then insert Upper Canopy (with logo brand) to the Pipe.  
將下罩蓋嵌入導管。然後將上罩蓋（印有品牌標誌）嵌入導管。

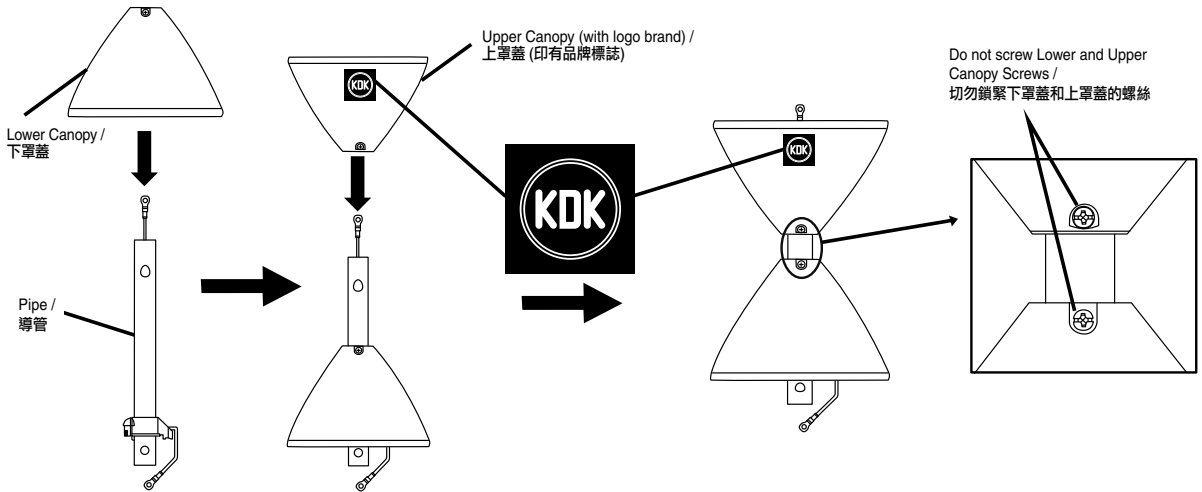

### Check Point After Installation / 安裝後的重點檢查

1. Insert the Lower and Upper Canopy to Pipe and the screw is not tightened. / 將下罩蓋和上罩蓋嵌入導管，並且螺絲沒被鎖緊。
2. Upper Canopy (with logo brand) is on top of Lower Canopy (no logo brand). / 上罩蓋（印有品牌標誌）是在下罩蓋（無品牌標誌）的頂部。

Check / 檢查

|                          |
|--------------------------|
| <input type="checkbox"/> |
| <input type="checkbox"/> |

## B) Assemble Pipe To Motor Assembly / 組裝導管至發動機組件

- 1** Pull the power cord (from power supply) and insert into the Pipe hole as shown.  
拉電纜（自電源）並如圖所示將之插入導管孔。

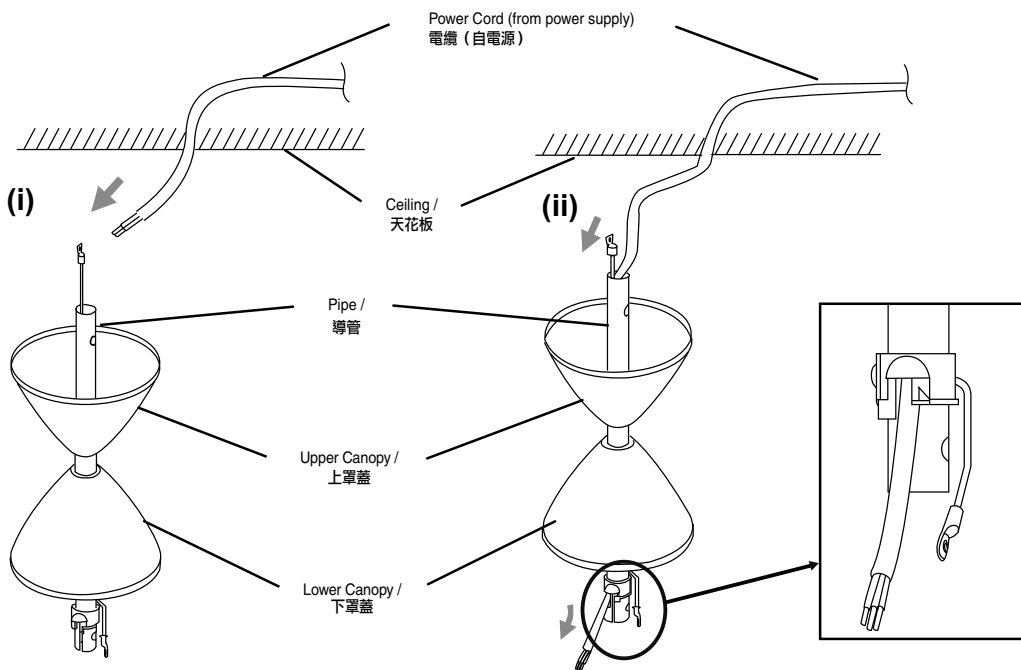

- 2** First, insert the Cap to the Motor Shaft. Then, fix the Pipe to Motor Shaft as shown. Ensure the Switch Lever press the Switch.  
 首先，將蓋子插入發動機轉動軸。然後如圖所示將導管安裝至發動機轉動軸。確定開關杆按壓開關。

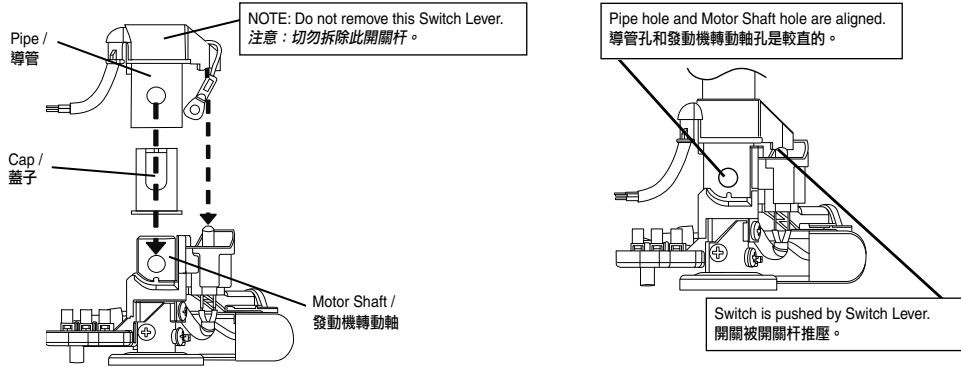

**CAUTION / 注意**

**!** Do not remove the Switch Lever at Pipe.  
 Insert Pipe correctly to Motor Shaft.  
 Can cause product not operate if Switch has not been pressed down.  
 切勿拆除導管上的開關杆。  
 將導管正確地插入發動機轉動軸。  
 若沒壓下開關可導致產品無法操作。

**⊘** Do not press Switch with other object, except using the Switch Lever given.  
 Can cause fire, explosion, short circuit and electrical shock.  
 除了使用原有的開關杆以外，切勿與其他東西同時推按開關。  
 這可導致火災、爆炸、短路及電擊。

- 3** Fix the Pipe and Motor Assembly with  
 a) Ellipse Bolt, b) P-R Washer, c) Spring Washer,  
 d) Hexa Nut and e) Cotter Pin. (All taken from Part Set)  
 The Slit position of the Bolt should be top and bottom.  
 Bend the Cotter Pin at last as shown.  
 使用以下物品組裝導管與發動機組件  
 a) 橢圓螺栓、b) P-R 墊圈、c) 彈簧墊圈、  
 d) 六角形螺帽 e) 開口銷。(全部取自零件組)  
 螺栓的縫隙必須位於頂部及底部。  
 最後所示折彎開口銷。

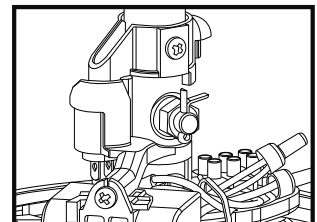
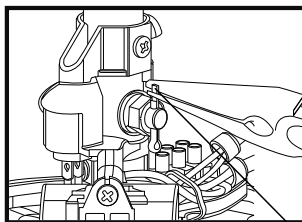
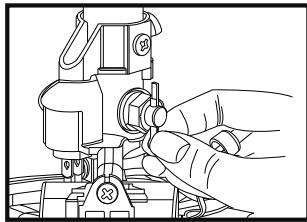
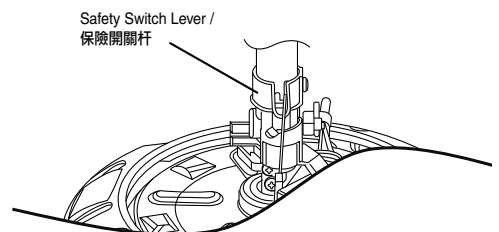
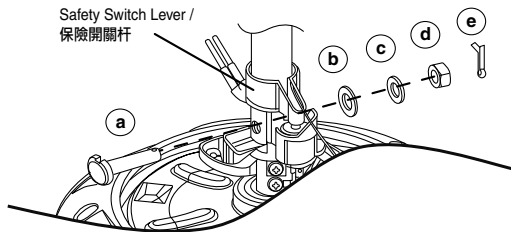
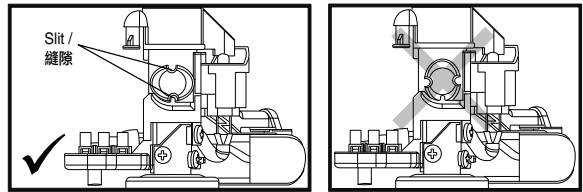

Cotter Pin is bent / 開口銷被折彎

**⚠ WARNING / 警告**



Ensure Pipe has been fully tightened to Motor Shaft. (Bolt tightening torque is 800~1200N•cm).  
 And, Cotter Pin must be fixed into Bolt hole and bent.  
 Can cause injury if Ceiling Fan drops.  
 確定將導管鎖緊至發動機轉動軸。(螺栓扭緊轉距是 800~1200N•cm)。而且，開口銷必須插入螺栓孔然後折彎。  
 若吊扇掉落會導致受傷。

- 4** Remove Safety Wire Screw at shaft.  
 Fix the Safety Wire firmly to the shaft with Safety Wire Screw.  
 拆開轉動軸上的保險線螺絲。  
 使用保險線螺絲將保險線固定於轉動軸。

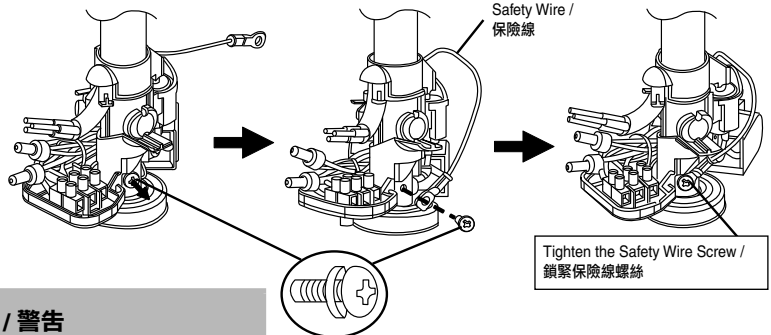

**⚠ WARNING / 警告**



Safety Wire must be fixed correctly and connected at all time.  
 Can cause injury if Ceiling Fan drops.  
 保險線必須正確地安裝並在任何時候都連接著。  
 若吊扇掉落會導致受傷。  
 Ensure the Safety Wire does not touch the Motor surface.  
 確定保險線沒有觸及發動機表面。

Safety Wire Screw (with washer) / 保險線螺絲 (配有墊圈)

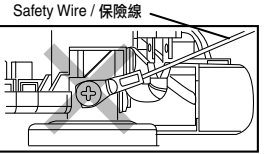
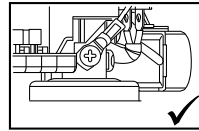

- 5** Connect the Power Cord to the 3 Pin Terminal.  
 連接電纜至 3 針端子。

**⚠ WARNING / 警告**



Make sure all the Terminals are connected correctly by competent personnel to avoid electrical hazards.  
 Can cause fire, electrical shock, Ceiling Fan drops and injuries.  
 請能勝任的人員確定所有端子已正確地連接以避免電氣危險。  
 這可導致火災、電擊、吊扇掉落及受傷。

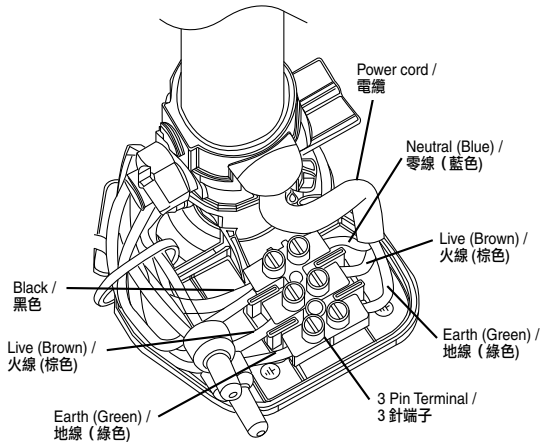

**Check Point After Installation / 安裝後的重點檢查**

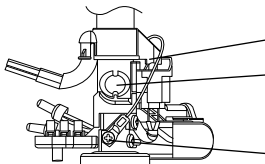

1. Switch Lever press the Switch. / 開關杆按壓開關。
2. The Ellipse Bolt, P-R Washer, Spring Washer and Hexa Nut are firmly tightened and the Cotter Pin is inserted and bent for safety reason. / 基於安全理由，橢圓螺栓、P-R墊圈、彈簧墊圈及六角形螺帽已鎖緊，而開口銷已插入並折彎。
3. Safety Wire Screw is firmly tightened. / 保險線螺絲已鎖緊。

Check

4. All wires are connected correctly by competent personnel. / 所有電線必須由能勝任的人員正確地連接。

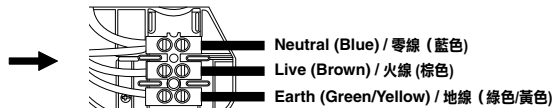
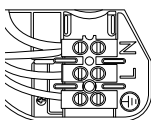



## C) Assemble Blade Assembly Set To Motor Assembly / 組裝扇翼組件至發動機組件

- 1** Remove Blade Screw (6 pieces, silver colour) from Motor Assembly.  
 Step 1 : Assemble Blade towards to the Cover Hook as shown in figure step 1.  
 Step 2 : Tighten the Blades firmly with Screws (Silver colour). Each Blade use 2 pieces of Screws.  
 (Tightening torque for reference : 250-300 N\*cm)

從發動機組件拆除扇翼螺絲 (6枚, 銀色)。  
 步驟1: 如步驟1的圖示, 將扇翼裝入罩鉤子。  
 步驟2: 以螺絲 (銀色) 鎖緊扇翼。每個扇翼使用2枚螺絲。  
 (扭緊轉距基準: 250-300N\*cm)。

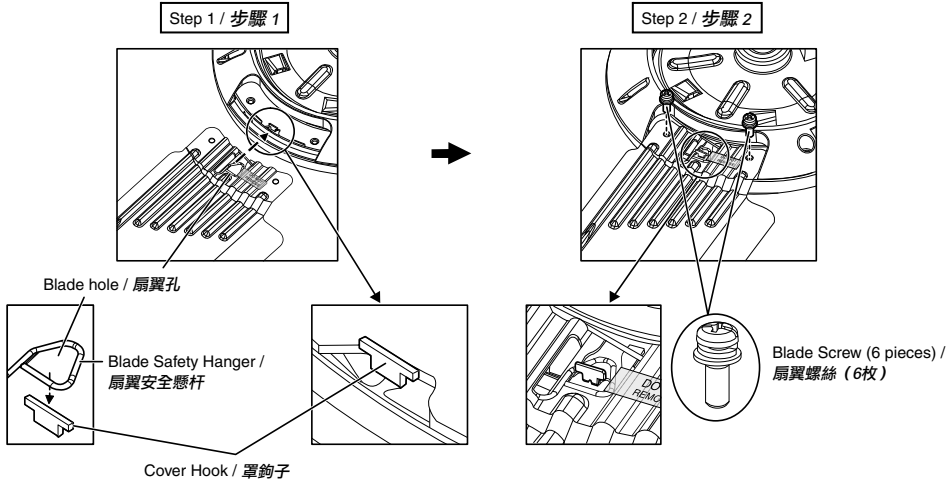

### CAUTION / 注意

**!** Blade must be fixed correctly.  
 Can cause no air flow.  
 Can cause injury if blades drop.  
 必須正確上緊扇翼。  
 這會導致沒有氣流。  
 若扇翼掉落會導致受傷。

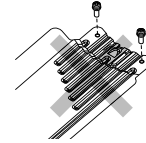
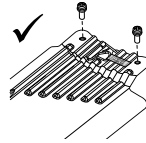

**!** Tighten the Blade Screws firmly using a screwdriver.  
 Can cause injury if Blade drops.  
 用螺絲起子將扇翼螺絲鎖緊。  
 若扇翼掉落會導致受傷。

**!** Do not remove Blade Safety Hanger from Blade.  
 Can cause injury if Blade drops.  
 不要移動扇翼的扇翼安全懸杆。  
 若扇翼掉落會導致受傷。

### Check Point After Installation / 安裝後的重點檢查

Check / 檢查

- The Blade Screws (6 pieces) for securing the Blade Assembly are tightly screwed. / 用於固定扇翼組件的扇翼螺絲 (6枚) 已鎖緊。
- Blade Safety Hanger must fix at the position on Blade. / 扇翼安全懸杆必須安裝在扇翼位置上。

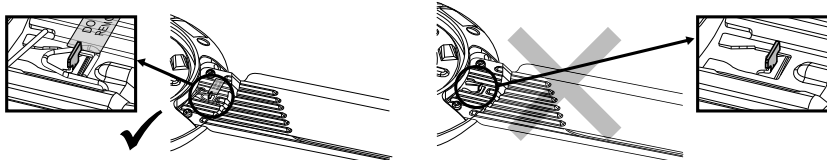

## D) Installation to Ceiling / 安裝至天花板

- 1** Before installation, check if the ceiling has Hook Set on it as shown.  
 It should have at least 3 Suspension Bolts.  
 If yes, Please follow Step D2 (Installation A) and, D3 (Installation A) before proceeding to Step 5.  
 安裝前, 檢查天花板是否有吊鉤組如圖所示。  
 它至少有3個懸掛螺栓。  
 如果有, 請按照步驟5, 然后再進行步驟D2的安裝 (安裝 A), 以及步驟 D3 (安裝 A)。

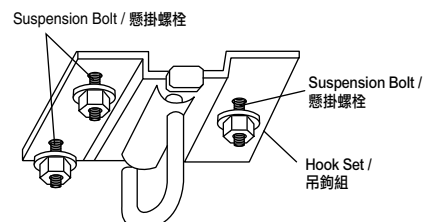

If No, please follow Step D2 (Installation B), D3 (Installation B) and Step 4 before proceeding to Step 5.  
 如果沒有, 請按照步驟5, 然后再進行D2的 (安裝B), 步驟D3 (安裝B) 和步驟 4 的安裝。

## 2 Drill hole. 鑽孔。

### ⚠ CAUTION / 注意

This Ceiling Fan is specially design for mounting above 2.5m from the floor.

Can cause injury if hit by the Blades.

Can cause unstable air flow and effect the Ceiling Fan to wobble.

本吊扇專門設計以掛在離地面 2.5米以上。

若被扇翼擊中，可以導致受傷。

可以導致不穩定氣流及吊扇搖晃。

Ensure Hook can afford more than 10 times the Ceiling Fan weight.

Can cause injury if Ceiling Fan drops.

確定鉤子可以承受超過吊扇的 10 倍重量。

若吊扇掉落會導致受傷。



### INSTRUCTION A / 指示 A

Make holes on the concrete ceiling. Drill  
①  $\varnothing$  6.5 mm (depth 30 mm) for Carl Bolt  
在混凝土天花板上鑽孔。鑽孔機：  
②  $\varnothing$  6.5 毫米 (深度 30 毫米) 給卡爾螺栓

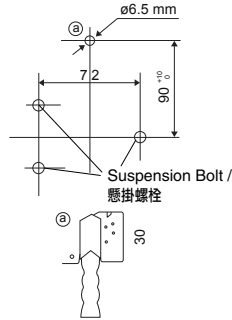

### INSTRUCTION B / 指示 B

Make holes on the concrete ceiling. Drill  
①  $\varnothing$  6.5 mm (depth 30 mm) for Carl Bolt  
②  $\varnothing$  12-12.5 mm (depth 35-40 mm) for 3  
Suspension Bolts (not supplied)  
在混凝土天花板上鑽孔。鑽孔機：  
③  $\varnothing$  6.5 毫米 (深度 30 毫米) 給卡爾螺栓  
④  $\varnothing$  12-12.5 毫米 (深度 35-40 毫米) 給 3 個  
懸掛螺栓 (不提供)

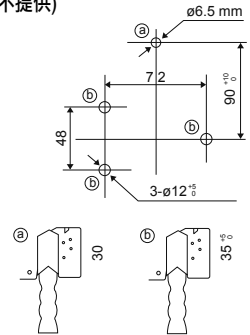

## 3 Install Bolt. 安裝螺栓。

### INSTRUCTION A / 指示 A

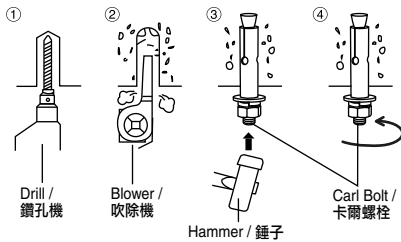

Install Carl Bolt  
安裝卡爾螺栓。

1. Make holes on the concrete ceiling as shown in Step 2.  
在混凝土天花板鑽個孔如圖所示步驟 2。
2. Use blower to remove dust in the holes.  
使用吹除機清除孔內的灰塵。
3. Insert Carl Bolt to hole (a).  
將卡爾螺栓插入孔 (a)。
4. Tighten the supplied Plain Washer, Spring Washer, Hexa Nut of the Carl Bolt. This is for making the Carl Bolt fix to the ceiling.  
鎖緊卡爾螺栓附帶的普通墊圈、彈簧墊圈、六角形螺帽。這是為了把卡爾螺栓固定在天花板。

### INSTRUCTION B / 指示 B

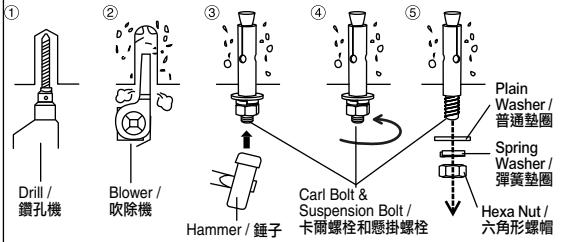

Install Carl Bolt and Suspension Bolts.  
安裝卡爾螺栓和懸掛螺栓。

1. Make holes on the concrete ceiling as shown in Step 2.  
在混凝土天花板鑽個孔如圖所示步驟 2。
2. Use blower to remove dust in the holes.  
使用吹除機清除孔內的灰塵。
3. Insert Carl Bolt to hole (a) Insert Suspension Bolts in hole (b).  
將卡爾螺栓插入孔 (a) 將懸掛螺栓插入孔 (b)。
4. Tighten the supplied Plain Washer, Spring Washer, Hexa Nut of the Carl Bolt and Suspension Bolts accordingly. This is for making the Carl Bolt and Suspension Bolts fix to the ceiling.  
鎖緊卡爾螺栓和懸掛螺栓附帶的普通墊圈、彈簧墊圈、六角形螺帽。這是為了把卡爾螺栓和懸掛螺栓固定在天花板。
5. Remove Hexa Nut, Spring Washer, and Plain Washer from the Suspension Bolts. Make sure Suspension Bolts are remained strong on the ceiling.  
將懸掛螺栓的六角形螺帽、彈簧墊圈和普通墊圈全部取出。確定懸掛螺栓仍然緊緊地固定在天花板上。

## 4 Install the Hook Set (For Instruction B only). 安裝吊鉤組 (只限於指示 B)。

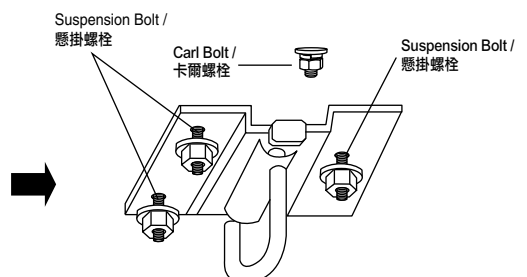
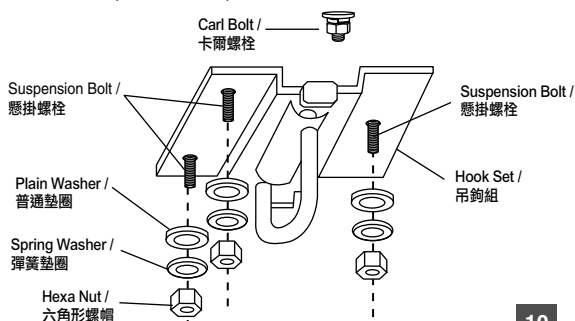

**5** Install to Ceiling.  
安裝至天花板。

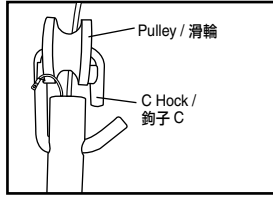

1st step / 步驟一  
Take out Pulley Set from Parts Set, after that cross it to Pipe.  
從零件組取出滑輪組件，隨後將其轉到導管上。

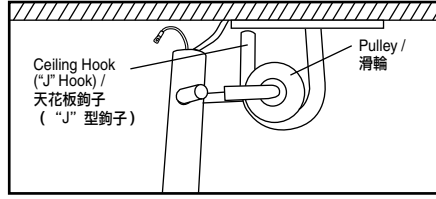

2nd step / 步驟二  
Place Pulley onto Ceiling Hook.  
將滑輪放在天花板鉤子上。

**ALTERNATIVE METHOD / 其他方式**

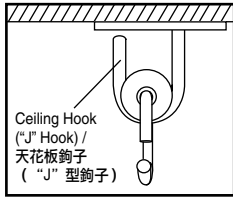

1st step / 步驟一  
Place the Pulley Set to the Ceiling Hook as shown in the picture.  
如圖所示將滑輪組件置入天花板鉤子。

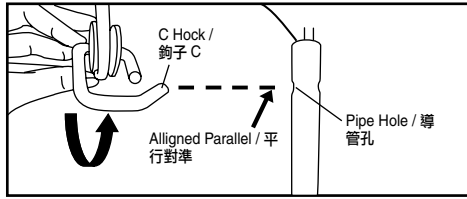

2nd step / 步驟二  
Incline Pulley Set and install Ceiling Fan.  
Make sure the Fan maintain straight to avoid the Blade from touching the ceiling during installation.  
使滑輪組件傾斜，然後安裝吊扇。  
請確保風扇保持筆直以避免扇翼在安裝過程中觸碰天花板。

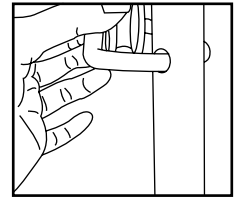

**WARNING / 警告**



Ensure Ceiling Hook can afford more than 10 times the Ceiling Fan weight.  
Can cause injury if Blades drops.  
確定天花板鉤子可以承受超過吊扇的 10 倍重量。  
若扇翼掉落會導致受傷。

**CAUTION / 注意**



Ensure Ceiling Fan is not tilted so that the Blade does not touch the ceiling during installation.  
Can cause unstable air flow and effect the Ceiling Fan to wobble.  
確保吊扇不傾斜，使扇翼在安裝過程中不觸及天花板。  
可以導致不穩定氣流和吊扇搖晃。

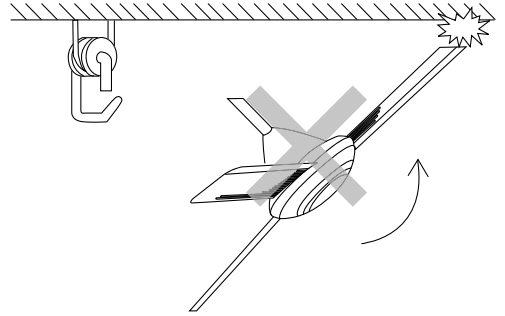

**6** Remove Hexa Nut, Spring Washer, and Plain Washer from hole @ Carl Bolt.  
Loop the Safety Wire to the Ceiling Hook and install Safety Wire as shown.  
Tighten the removed Plain Washer, Spring Washer and Hexa Nut.  
將◎卡爾螺栓的六角形螺帽、彈簧墊圈和普通墊圈全部從孔取出。  
如圖所示將保險線圈結至天花板鉤子並安裝保險線。  
鎖緊取出的普通墊圈、彈簧墊圈、六角形螺帽。

**CAUTION / 注意**



The fan suspension system should be examined regularly at least once in two years.  
Can cause injury if Ceiling Fan drops.  
必須至少每兩年定期為風扇懸掛系統進行檢查。  
若吊扇掉落會導致受傷。

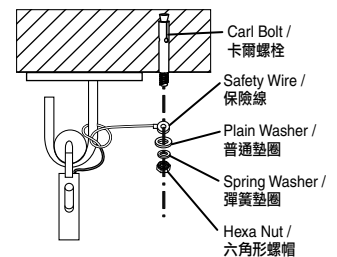
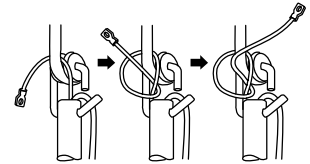

## Check Point After Installation / 組裝後的檢驗點

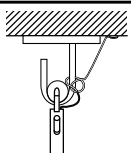

1. The Ceiling Fan is securely fixed onto the hanging hook. / 吊扇被穩固地安裝到吊鉤上。
2. The The Safety Wire is securely fixed onto ceiling. / 保險線已穩固地安裝在天花板上。

Check / 檢查

## E) Wiring Instruction / 配線指示

- 1 Connect power supply according to the Wiring Instruction below.  
按照以下的配線指示接電源。

### ⚠ WARNING / 警告



Electrical wiring must be done by competent personnel.  
Can cause fire, electrical shock, Ceiling Fan drops and injuries.  
電線配線工作必須由能勝任的人員進行。  
這可導致火災、電擊、吊扇掉落及受傷。

### WIRING DIAGRAM / 電線圖

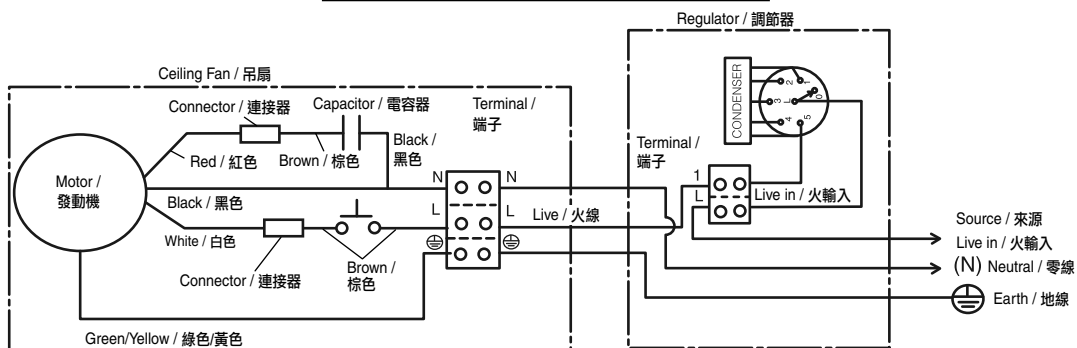

### CONNECTING THE POWER SUPPLY / 連接電源

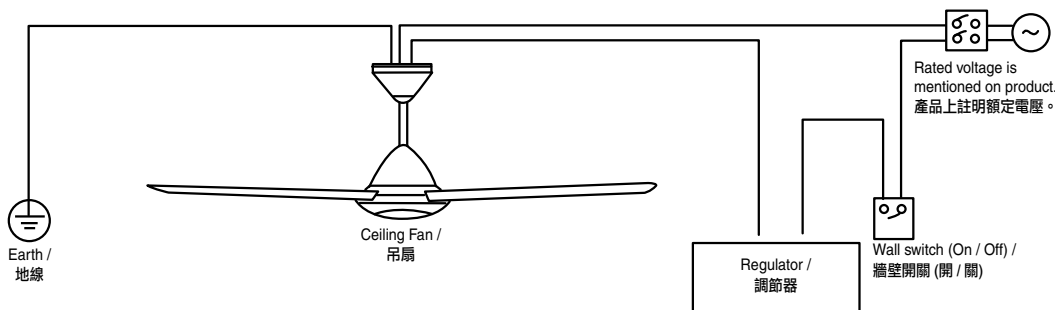

### ⚠ CAUTION / 注意



This product is not provided with cord and plug or with other means for connection from the supply. When connect or change the power cord or lead wire, it must be performed by qualified personnel in order to avoid a hazard. Please use 227IEC53(RVV) or thickness of tube is 1mm or above. (Other requirements such as diameter of lead wire, please use according to the regulation of the country). This product should be installed with a double poles single throw switch (Breaker Switch) with minimum 3mm contact gap in the fixed installation circuit.

此產品沒有提供電纜和插頭或其他用作接駁電源的附件。當連接或替換電纜或電線時，這項工作必須交由能勝任的人員執行以防危險。請使用227IEC53(RVV)或厚度超過1毫米的導管。(其他要求，例如電線直徑等等，請遵守相關國家的條例)。此產品必須在固定安裝電路上裝上觸點間隙為最少3毫米的雙極單投開關(斷路開關)。



## CAUTION / 注意



Should there be a dimmer switch, disconnect it and reconnect the wiring as shown.  
如果有調光開關，切斷該連接，然後如圖所示再次進行接線。

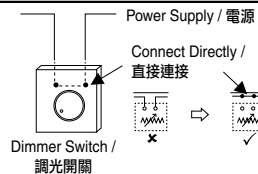

### Check Point After Installation / 安裝後的重點檢查

Check / 檢查

1. The wiring is connected properly to the power supply.  
電線已正確地連接了電源線。



## F) Fix the Canopy / 安裝罩蓋

- 1 Adjust Upper Canopy position and fix Upper Canopy to Pipe firmly by screwing them as shown.  
The distance of Upper Canopy and Ceiling is approximately 5mm.  
調整上罩蓋的位置，然後如圖所示將上罩蓋旋緊至導管。  
上罩蓋與天花板的距離大約是 5 毫米。

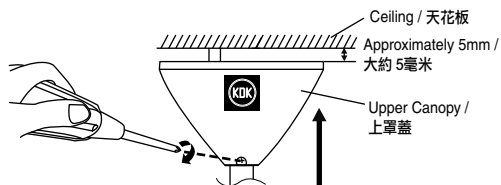

- 2 Pull down Lower Canopy until it stop and fix to Pipe firmly by screwing them as shown.  
如圖所示拉下下罩蓋直至下罩蓋停止，然後將之旋緊至導管。

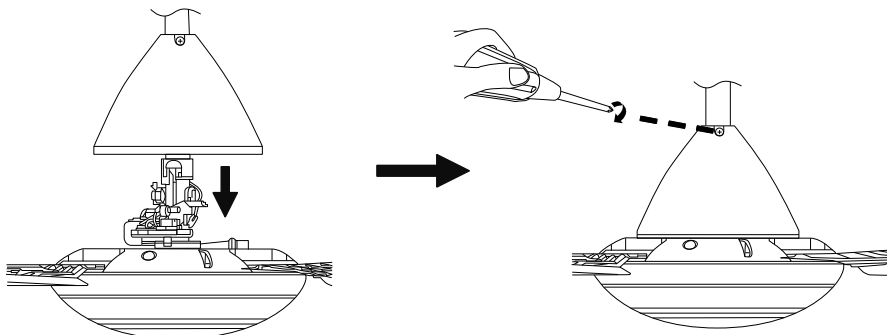

### Check Point After Installation / 安裝後的重點檢查

Check / 檢查

1. The Upper Canopy is securely fixed.  
上罩蓋已固定。
2. The Lower Canopy is securely fixed.  
下罩蓋已固定。



## G) Installation of Speed Regulator / 調速器的安裝

- 1 The dimension for the Speed Regulator is shown in the Diagram.  
調速器的尺寸如圖所示。

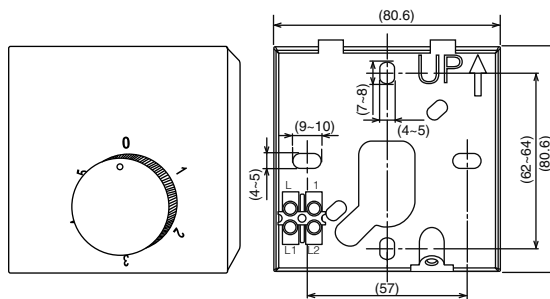

200V Class Regulator / 200V 等級調節器

- 2** Loosen the screw from the Speed Regulator Cover. Open the Speed Regulator by lifting up the Speed Regulator Cover from the base.  
鬆開調速器蓋子上的螺絲。從底部提起調速器蓋子以打開調速器。

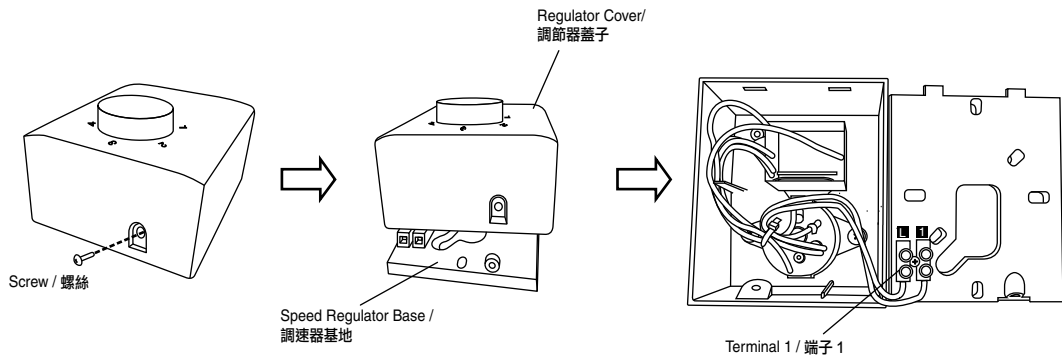

- 3** Insert the live wire from the wall through the hole of the Speed Regulator Base as shown.  
如圖所示將火線從牆壁通過調速器底部的孔插入。

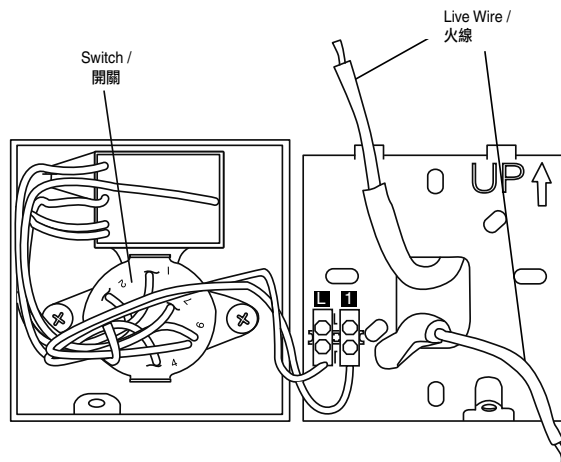

- 4** Fix the Speed Regulator box to the wall by screwing the screws as shown.  
如圖所示鎖緊螺絲以安裝調速器箱至牆壁。

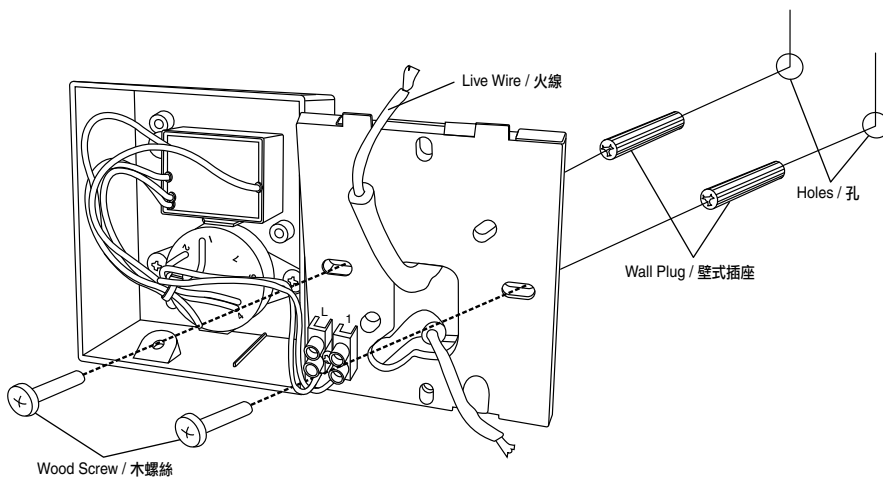

**ATTENTION / 留意**

Wood Screw and Wall Plug is not supplied.  
木螺絲和壁式插座並不提供。

- 5** Connect the Live Wire with the Terminal as shown.  
如圖所示連接火線與端子。

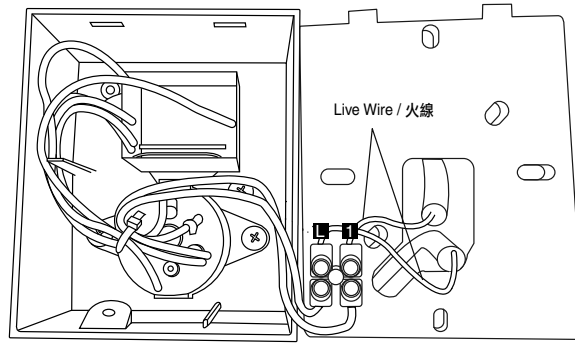

- 6** To close the Speed Regulator, insert the two holes on top of the Speed Regulator to the two protruding parts at the base. Finally, screw them together.  
將調速器頂部的兩個孔插入底部的兩個突出部分以關閉調速器。最後，以螺絲將它們鎖緊。

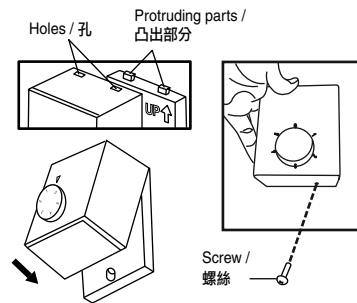

## H) Final Confirmation / 最後確認

- 1** Measure the distance using a measuring tape.  
Please adjust all the Blades to get the equal distance from ceiling to the Blade Tip, L (within 1 mm tolerance).  
使用捲尺測量距離。  
請調整所有扇翼，使天花板至扇翼末端L的距離相等（1毫米公差之）。

**⚠ CAUTION / 注意**

After installation make sure the Ceiling Fan does not wobble extremely.  
Can cause injury if Ceiling Fan drops.  
安裝后，請確定吊扇不會過度搖晃。  
若吊扇掉落會導致受傷。

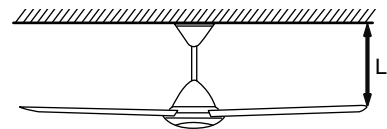

### Pitching Method / 校準方法

Hold the Motor Assembly by hand and adjust the Blade carefully until the height (L) differences is  $\pm 1$  mm.  
用手握住發動機組件，然後小心調整扇翼直至高度 (L) 的差異為  $\pm 1$  毫米。

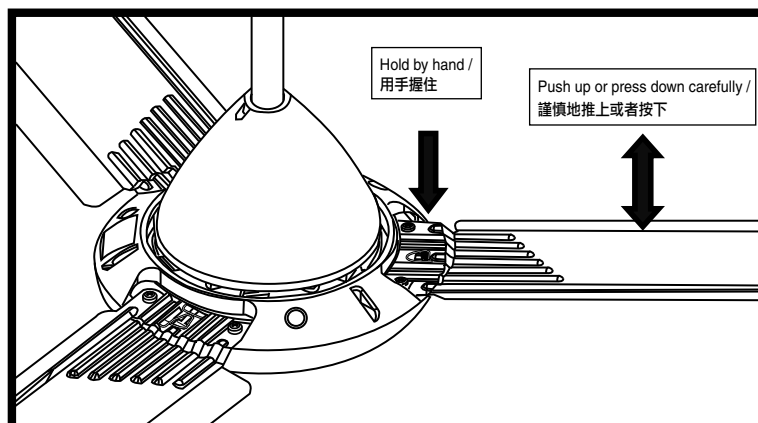

# How To Use / 如何使用

- 1** To turn on the fan, simply turn the Switch Knob to any position (1, 2, 3, 4, or 5). To turn off the fan, turn the Switch Knob to the (0) position.  
要開啟風扇，只需將開關旋鈕轉至任何位置（1、2、3、4或5）。要關閉風扇，將開關旋鈕轉至（0）位置。

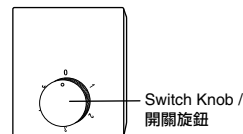

# Maintenance / 維修

1. Check the Ceiling Fan condition annually. If a problem occurs, stop using the Ceiling Fan. Then refer to service, sales or maintenance shop. Check points : Loosened Screws, Safety Wire condition, Motor Shaft damage, etc.  
每年檢查吊扇的狀況。如果出現問題，停止使用有關吊扇。然後質詢服務、銷售或維修商店。  
檢驗點：螺絲松脫、保險線狀況、發動機轉動軸損壞等等。
2. Keep the Ceiling Fan clean. Wipe away dirt with a clean soft cloth, ordinary soap and water. Wipe it again to dry it. Do not use solvents (Gasoline or petroleum).  
\* Please do not bend the Blade while cleaning.  
保持吊扇清潔。用乾淨的軟布、普通肥皂和水抹去汙跡。再抹一次將之抹乾。切勿使用溶劑（汽油或石油）。  
\* 清洗扇翼時請切勿折彎扇翼。
3. Do not paint the Blades. If damage, order new set of Blades (3 pieces) from service shop or sales shop.  
切勿為扇翼塗漆。若扇翼損壞了，請向服務商店或銷售商店訂購新的扇翼（3片）。
4. When referring to service, sales or maintenance shop, show this instruction to them and maintain correctly.  
當您質詢服務、銷售或維修商店時，請向他們出示此指示以便他們正確地進行維修。
5. If the product is broken or damage, please remove the Ceiling Fan from ceiling and replace with a new Ceiling Fan. This is to avoid the Ceiling Fan drops.  
若產品已折斷或損壞，請從天花板上拆除吊扇，然後換上新的吊扇。這是為了防止吊扇掉落。
6. Recommendation for the Ceiling Fan suspension system shall be examined at least once every two years.  
建議每兩年至少檢查吊扇懸掛系統一次。

# Product Specification / 產品規格

| Model<br>模型 | Type<br>類型 | Voltage<br>電壓 | Frequency<br>頻率 | Wattage (W)<br>瓦特數 (W) |           | Rotation (RPM)<br>旋轉度 (RPM) |           | Air Velocity (m/min)<br>風速 (米/分鐘) | Air Delivery<br>(m <sup>3</sup> /min)<br>送風量<br>(立方米/分鐘) |
|-------------|------------|---------------|-----------------|------------------------|-----------|-----------------------------|-----------|-----------------------------------|--|
|             |            | VAC<br>伏特交流   | Hz<br>赫茲        | Low<br>低               | High<br>高 | Low<br>低                    | High<br>高 |                                   |  |
| M48SG       | TB         | 220           | 50              | 15                     | 45        | 137                         | 285       | 160                               | 155  |
|             |            | 230           |                 | 16                     | 49        | 146                         | 296       | 165                               | 170  |
| M60SG       | TB         | 220           | 50              | 15                     | 66        | 94                          | 225       | 150                               | 215  |
|             |            | 230           |                 | 16                     | 71        | 97                          | 233       | 160                               | 225  |